

Architectural
elements

CO
AV
R
O

IBAO



— A legacy of craftsmanship

1970 marked the birth of a vision. A vision of always innovating, always transforming. Pushing the boundaries of material science. For over fifty years, our passion for innovation has driven us from crafting ornate decor to pioneering technology materials in the industry, to Duropolymer. Always seeking to infuse the enduring with the revolutionary.

With each turn of the calendar, we — at Orac — have transcended our original identity. From our genesis as Orac to our expansion into Orac Decor, our journey now brings us back to where it all began: Orac, coming full circle. We are more than artisans of decor; we are pioneers, visionaries, storytellers of interior.

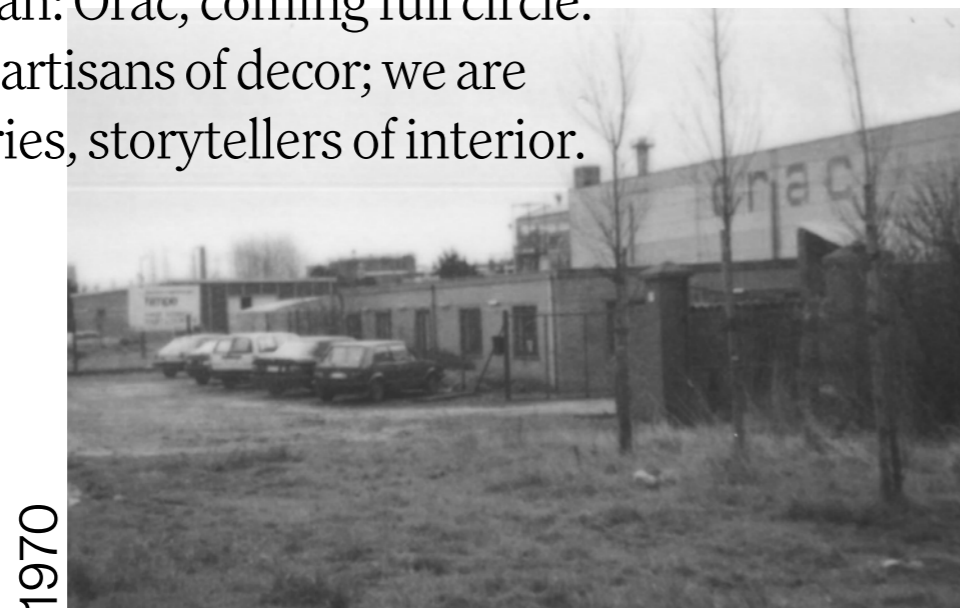

Start of Ostend Research and Application Company

1980



Focus on decorative ornaments

1992



Introduction of flexible products

2000



Start of extrusion

2002



Second generation management

2010



Solar field and ISO14001 certification

2012



Modern concept

ORAC

We shed our old skin — Orac Decor — to emerge simply as Orac, a name that encapsulates our essence and our expansive vision for the future.

NL —

1970 betekende de geboorte van een visie. De visie om altijd te innoveren, om altijd te transformeren. Om de grenzen van materiaalwetenschap te verleggen. Sinds meer dan vijftig jaar drijft onze passie voor innovatie ons tot de creatie van sierlijke ornamenten, baanbrekende technologische materialen alsook Duropolymer. We zijn altijd op zoek naar de brug tussen het blijvende en het revolutionaire. Met elk nieuw kalenderjaar hebben wij - bij Orac - onze originele identiteit overstege. Van ons ontstaan als Orac tot onze uitbreiding naar Orac Decor, brengt onze reis ons nu terug naar waar het allemaal begon: we zijn opnieuw Orac, de cirkel is rond. We zijn meer dan ambachtslieden in decor; we zijn pioniers, visionairs, verhalenvertellers op vlak van interieur.

FR —

1970 a marqué la naissance d'une vision. La vision de toujours innover, de toujours transformer. Repousser les limites de la science des matériaux. Depuis plus de cinquante ans, notre passion pour l'innovation nous a conduits de la fabrication d'ornements décoratifs à la création de matériaux technologiques pionniers dans l'industrie jusqu'au Duropolymer. Nous cherchons toujours à marier le révolutionnaire au durable. À chaque tournant du calendrier, nous - chez Orac - avons transcendé notre origine. De notre genèse en tant qu'Orac à notre expansion en tant qu'Orac Decor, notre voyage nous ramène aujourd'hui là où tout a commencé : Orac, la boucle est bouclée. Nous sommes plus que des artisans de la décoration ; nous sommes des pionniers, des visionnaires, des narrateurs dans le monde de l'intérieur.

DE —

1970 war die Geburtsstunde einer Vision. Einer Vision der ständigen Innovation, des ständigen Wandels. Die Grenzen der Materialwissenschaft zu überschreiten. Seit über fünfzig Jahren treibt uns unsere Leidenschaft für Innovation an - von der Herstellung kunstvoller Dekore bis hin zu bahnbrechenden technologischen Materialien wie Duropolymer. Immer mit dem Bestreben, das Beständige mit dem Revolutionären zu verbinden. Mit jedem Jahr sind wir - bei Orac - über unsere ursprüngliche Identität hinausgewachsen. Von unserer Entstehung als Orac bis zu unserer Expansion zu Orac Decor führt uns unsere Reise nun dorthin zurück, wo alles begann: Orac, womit sich der Kreis schließt. Wir sind mehr als Dekorationshandwerker; wir sind Pioniere, Visionäre, Geschichtenerzähler der Inneneinrichtung.

ES —

1970 marcó el nacimiento de una visión. Una visión de innovar siempre, de transformarse constantemente. Superando los límites de la ciencia de los materiales. Durante más de cincuenta años, nuestra pasión por la innovación nos ha llevado desde la fabricación de elementos decorativos a materiales pioneros en la industria de la tecnología hasta llegar al Duropolymer. Siempre buscando combinar lo perdurable con lo revolucionario. Con cada giro del calendario, en Orac hemos trascendido a nuestra identidad original. Desde nuestra génesis como Orac hasta nuestra expansión a Orac Decor, nuestro viaje nos lleva ahora de Vuelta al punto de partida: Orac, cerrando así el círculo. Somos más que artesanos de la decoración; somos pioneros, visionarios y narradores del interiorismo.

At Orac, we've always believed that there are many sides to a wall, and we are committed to choosing the good one. In a world where design often feels transient, we've chosen a different path.



Sustainability goes beyond the use of recycled materials; it's about designing ideas that stand the test of time. We understand that true sustainability means creating products that remain relevant for generations, not just a few fleeting years.



— A commitment carved in walls

NL —
Bij Orac geloven we al sinds jaar en dag dat een muur vele kanten heeft, en wij zetten ons in om steeds de goeie kant te kiezen. In een wereld waar design vaak vluchtig is, bewandelen wij een ander pad. Duurzaamheid reikt verder dan het gebruik van gerecycleerde materialen, het gaat om het creëren van concepten die de tand des tijds doorstaan. We begrijpen dat echte duurzaamheid inhoudt dat we producten maken die generaties lang meegaan, en niet slechts enkele voorbijgaande jaren relevant zijn.

DE —
Wir bei Orac haben schon immer daran geglaubt, dass eine Wand viele Seiten hat, und wir haben uns entschieden, die gute Seite zu wählen. In einer Welt, in der sich Design oft vergänglich anfühlt, haben wir einen anderen Weg gewählt. Nachhaltigkeit geht über die Verwendung recycelter Materialien hinaus; es geht darum, Ideen zu entwickeln, die Bestand haben. Wir wissen, dass echte Nachhaltigkeit bedeutet, Produkte zu schaffen, die für Generationen relevant bleiben, nicht nur für ein paar flüchtige Jahre.

FR —
Chez Orac, nous pensons qu'un mur peut avoir plusieurs aspects, et nous nous engageons à choisir le meilleur. Dans un monde où le design peut sembler éphémère, nous avons pris une voie différente. Pour nous, la durabilité va au-delà de l'utilisation de matériaux recyclés, c'est trouver des idées de conception qui durent dans le temps. La véritable durabilité signifie créer des produits pertinents pour les générations à venir, et pas seulement pour quelques années.

ES —
En Orac siempre hemos creído que una pared tiene muchas caras, y nosotros nos comprometemos a elegir la buena. En un mundo en el que el diseño parece ser efímero, nosotros elegimos perdurar. La sostenibilidad va más allá del uso de materiales reciclados; se trata de diseñar ideas que resistan el paso del tiempo. Entendemos que la verdadera sostenibilidad significa crear productos que sigan siendo relevantes durante generaciones y no unos pocos años.



— Every wall is a blank canvas



Where others see a flat surface, we see a world of possibilities. A clean primer, waiting for a little intervention. A bare base, in need of shape and dimension. A neutral support, asking to be someone's project and the centre of their attention. Which is all why, at Orac, we like to say we're visual artists of sorts — taking walls as a field of experimentation and at any time, seeking to honour their unique creative potential.

NL —

Waar anderen niet meer dan een vlakte zien, ontvouwt zich voor ons een horizon vol mogelijkheden. Een ongerept doek, klaar voor een creatieve ingreep. Een lege basis die smacht naar vorm en diepte. Een neutrale wand die uitnodigt om het hart van iemands project te worden. Dat is de reden waarom we bij Orac onszelf beschouwen als beeldhouwers van de ruimte – we omarmen muren als ons atelier voor experiment en ontdekking, altijd op zoek om hun unieke creatieve essentie tot uiting te laten komen.

FR —

Là où d'autres voient une surface plane, nous voyons un monde de possibilités. Un socle impeccable, qui attend une petite intervention. Une base vierge, qui a besoin d'une forme et d'une dimension. Un support neutre, qui demande à être le projet de quelqu'un et le centre de son attention. C'est pourquoi, chez Orac, nous aimons dire que nous sommes des sortes d'artistes visuels, considérant les murs comme un champ d'expérimentation et cherchant à tout moment à honorer leur potentiel créatif unique.

DE —

Wo andere eine flache Oberfläche sehen, sehen wir eine Welt voller Möglichkeiten. Eine makellose Grundlage, die auf einen kleinen Eingriff wartet. Eine blanke Basis, der es an Form und Dimension mangelt. Eine neutrale Fläche, die darauf wartet, das Projekt von jemandem zu sein und im Mittelpunkt der Aufmerksamkeit zu stehen. Aus diesem Grund bezeichnen wir uns bei Orac als eine Art visuelle Künstler, die Wände als Experimentierfeld nutzen und stets versuchen, ihr einzigartiges kreatives Potenzial zu entfalten.

ES —

Donde otros ven una superficie plana, nosotros vemos un mundo de posibilidades. Una superficie limpia, a la espera de una pequeña transformación. Una base neutra que necesita forma y dimensión. Un lienzo en blanco, que pide ser el proyecto de alguien y el centro de su atención. Por eso, en Orac nos gusta decir que somos como artistas visuales, que consideramos las paredes como campo de experimentación y tratamos en todo momento de honrar su potencial creativo único.





Whether it's a touch of the contemporary or a nod to the classics, each of our products is a chameleon, adept at taking on the character you desire. Here are some glimpses into the myriad of ways our products can animate, define and transform interiors.

Every setting, every angle reveals new potential. A new story to be told.

Unexpected possibilities

NL –

Of het nu een moderne flair is of een knipoog naar het klassieke, onze producten zijn net kameleons die naadloos samenvloeien met hun omgeving en toch een uniek karakter behouden. Laat u inspireren door de subtiele kunst van verfijning en ontdek hoe de kleinste aanraking een ruimte kan omtoveren tot een canvas van persoonlijke expressie. Met Orac aan je zijde is elke ruimte een uitdaging om te dromen, te ontwerpen en te inspireren.

FR –

Des possibilités inattendues. Qu'il s'agisse d'une touche contemporaine ou d'un clin d'œil aux classiques, chacun de nos produits est un caméléon, capable de prendre le caractère que vous souhaitez. Nous aimons vous donner un aperçu de la myriade de façons dont nos produits peuvent agrémenter, définir et transformer les espaces. Chaque décor, chaque angle révèle un nouveau potentiel. Une nouvelle histoire à raconter.

DE –

Unerwartete Möglichkeiten. Ob mit einem Hauch von Modernität oder einer Anspielung auf die Klassiker: Jedes unserer Produkte ist ein Chamäleon, das den von Ihnen gewünschten Charakter annehmen kann. Wir geben Ihnen gerne einen Einblick in die unzähligen Möglichkeiten, wie unsere Produkte animieren können, Räume zu definieren und zu transformieren. Jede Umgebung, jeder Blickwinkel, eröffnet neue Möglichkeiten. Eine neue Geschichte, die erzählt werden muss.

ES –

Posibilidades inesperadas. Ya se trate de un toque contemporáneo o de un guiño a los clásicos, cada uno de nuestros productos es un camaleón, capaz de adoptar el carácter que se le quiera dar. Aquí hay algunos ejemplos de las innumerables formas en que nuestros productos pueden animar, definir y transformar espacios. Cada escenario, cada ángulo revela un nuevo potencial. Una nueva historia que contar.

Content

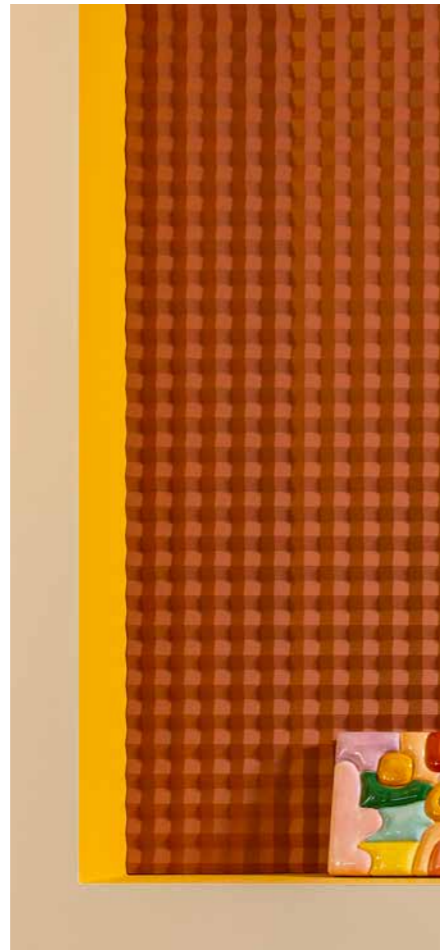

EN –

9 Unexpected possibilities

- 12 About today
- 22 Uncut modern
- 32 Vibrant allure
- 44 Essential still

57 Products

- 58 Materials
- 62 Product Overview
- 64 — 01 Cornice mouldings
- 92 — 02 3D Wall covering
- 108 — 03 Skirting boards
- 122 — 03 Panel mouldings
- 134 — 05 Indirect lighting
- 148 — 06 Deco elements
- 158 — 07 The perfect finish
- 162 — 08 Flexible products

NL –

9 Onverwachte mogelijkheden

- 12 Over vandaag
- 22 Onversneden modern
- 32 Levendige allure
- 44 Nog steeds essentieel

57 Producten

- 58 Materialen
- 62 Productoverzicht
- 64 — 01 Kroonlijsten
- 92 — 02 3D Wandbekleding
- 108 — 03 Plinten
- 122 — 04 Wandlijsten
- 134 — 05 Indirecte verlichting
- 148 — 06 Decoratieve elementen
- 158 — 07 De perfecte afwerking
- 162 — 08 Flexibele producten

FR –

9 Des possibilités inattendues

- 12 À propos d'aujourd'hui
- 22 Moderne à l'état pur
- 32 Allure vibrante
- 44 Essentiel encore

57 Produits

- 58 Matériaux
- 62 Aperçu produits
- 64 — 01 Corniches
- 92 — 02 Revêtements muraux 3D
- 108 — 03 Plinthes
- 122 — 04 Cimaises
- 134 — 05 Éclairage indirect
- 148 — 06 Éléments décoratifs
- 158 — 07 La finition parfaite
- 162 — 08 Produits flexibles

DE –

9 Unerwartete Möglichkeiten

- 12 Über das Heute
- 22 Unverfälscht modern
- 32 Lebendige Anziehungskraft
- 44 Immer essentiell

57 Produkte

- 58 Materialien
- 62 Produktübersicht
- 64 — 01 Stuckleisten
- 92 — 02 3D Wandvertäfelung
- 108 — 03 Sockelleisten
- 122 — 04 Wand- und Friesleisten
- 134 — 05 Indirekte Beleuchtung
- 148 — 06 Zierelemente
- 158 — 07 Die perfekte Installation
- 162 — 08 Biegbare Produkte

ES –

9 Posibilidades inesperadas

- 12 Sobre el presente
- 22 Moderno sin cortes
- 32 Atractivo vibrante
- 44 Todavía esencial

57 Productos

- 58 Materiales
- 62 Resumen de productos
- 64 — 01 Cornisas
- 92 — 02 Revestimientos de pared 3D
- 108 — 03 Zócalos
- 122 — 04 Molduras
- 134 — 05 Iluminación indirecta
- 148 — 06 Elementos decorativos
- 158 — 07 El acabado perfecto
- 162 — 08 Productos flexibles

About today

At times, the modern is inclined to the here and now. Freed from the transience of fashion, it reveals a classic for the future. We are delighted to see it happen. The legacy of an era is revisited to create something new.

NL –

Momenten waarop de frisse geest van het nieuwe de echo's van traditie ontmoet. Ontdek hoe, op basis van de erfenis van een tijdperk, de klassiekers van morgen ontvouwen. Een erfgoed opnieuw bezocht, met een stoutmoedige aanraking die hulde brengt aan het heden en een knipoog geeft naar de toekomst.

DE –

Zuweilen tendiert die Moderne zum aktuellen Trend. Befreit von der Vergänglichkeit der Mode, entpuppt sie sich als Klassiker für die Zukunft. Wir freuen uns zu sehen, wie das geschieht. Das Erbe einer Ära wird wieder aufgegriffen, um etwas Neues zu schaffen. Eine gewagte Hommage an die Gegenwart und die Zukunft.

FR –

Parfois, le moderne est tourné vers le présent. Libéré de l'éphémère de la mode, il révèle un classique pour l'avenir. Nous sommes ravis de voir cela se produire. L'héritage d'une époque est revisité pour créer quelque chose de nouveau. Une touche d'audace en hommage au présent et à demain.

ES –

A veces, lo moderno se inclina hacia el presente. Liberándose de la moda efímera y revelando un clásico para el futuro. Estamos encantados de que así sea. El legado de una época se reinterpreta para crear algo nuevo. Un toque atrevido en homenaje al presente y al mañana.



1. C990 p.77 2. CX188 p.142 3. PX209 p.131 4. W217 p.99 5. W218 p.99 6. SX182 p.111

NL —
Wit ontmoet primaire kleuren: een gedurfd, contrasterend samenspel.

FR —
Le blanc rencontre les couleurs primaires : un jeu audacieux et contrasté.

DE —
Weiß trifft auf Primärfarben: Ein mutiges, kontrastreiches Zusammenspiel.

ES —
El blanco se une a los colores primarios: un juego atrevido y lleno de contrastes.

ORAC

Unexpected possibilities

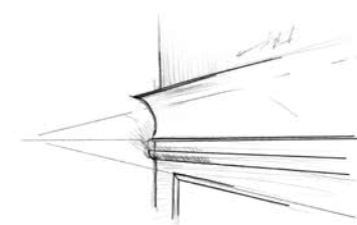

C990 INFINITY + CX188

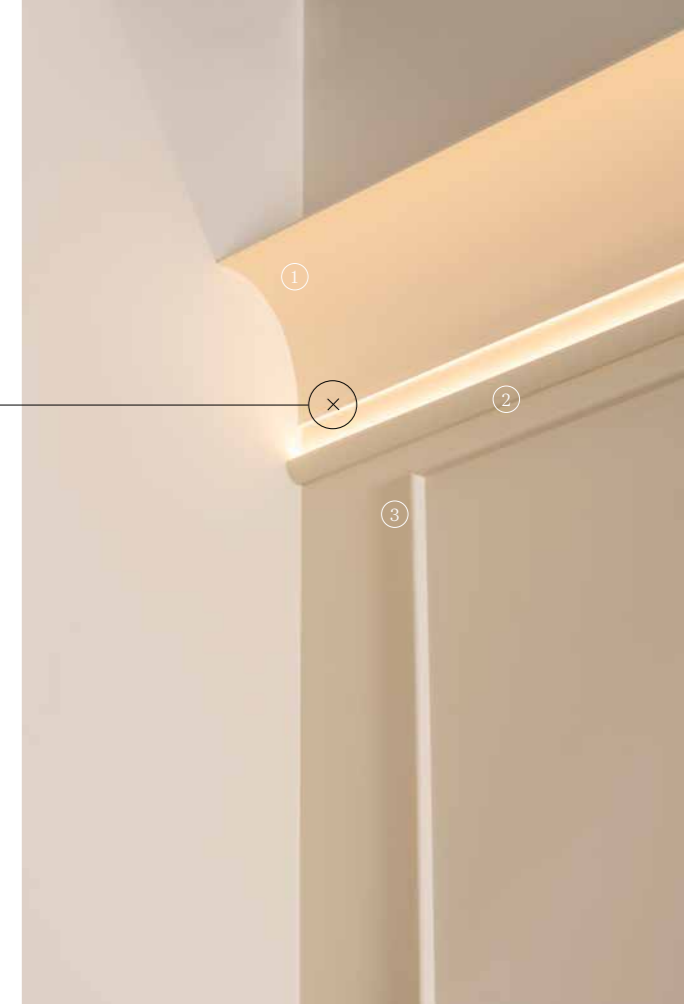

1. C990 p.77 2. CX188 p.142 3. PX209 p.131

3. PX209 p.131



White meets primary colours: a bold, contrasting interplay.

About today

NL —
Grote 3D-vormen zorgen voor een gedurfde esthetische ruimte.

FR —
Des formes 3D importantes façonnent un espace au design audacieux.

DE —
Große 3D-Formen schaffen einen kühnen, ästhetischen Raum.

ES —
Las grandes formas tridimensionales esculpen un espacio atrevido e impactante.

1. W115 p.102

Large 3D shapes carve out a boldly aesthetic space.

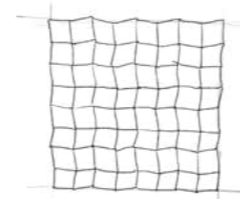
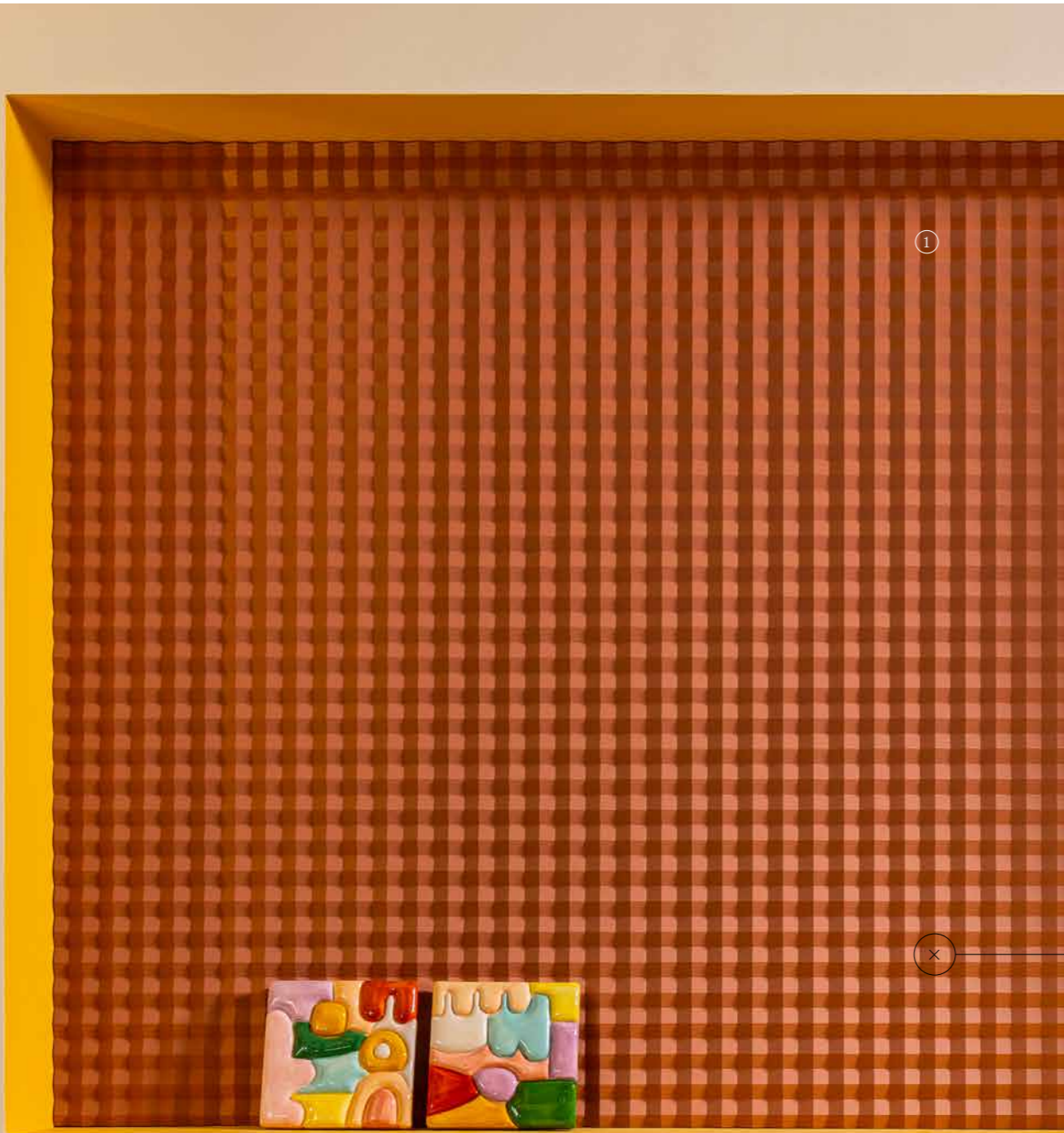

W115 SLOPE

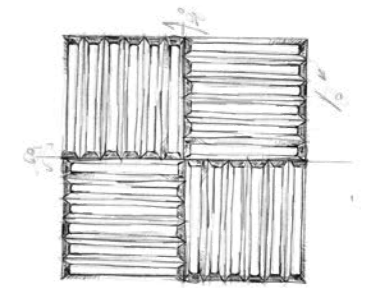

W218 QUILT



2. W218 p.99 3. W217 p.99 4. SX182 p.111

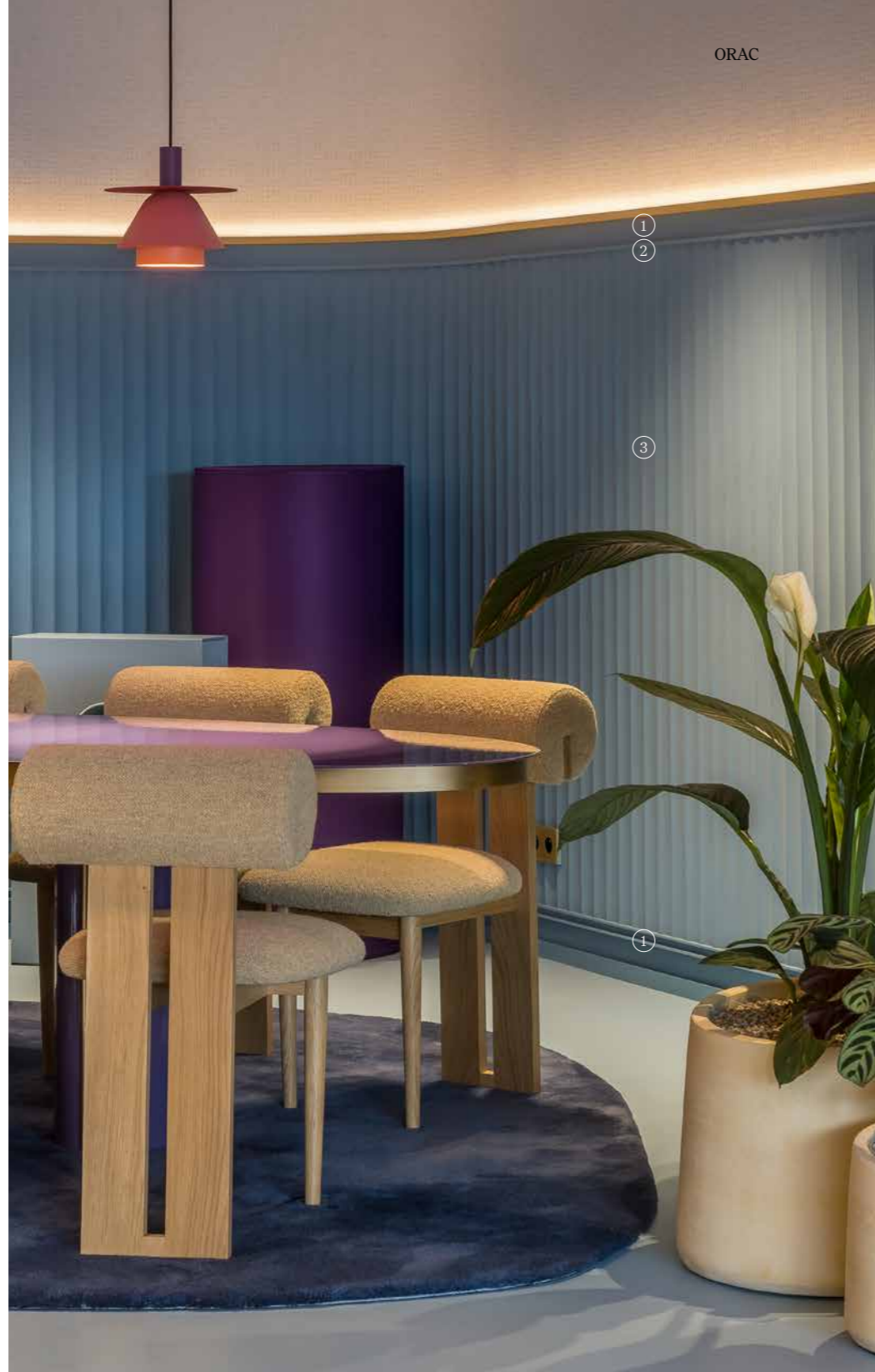

ORAC

Unexpected possibilities

Eclectic blend of rounded 3D panels and vivid colour contrasts.

¹ CX190 | CX190F p.142 ² SX194 | SX194F p.131 ³ W114 | W114F p.98



¹ CX190 | CX190F p.142 ² SX194 | SX194F p.131 ³ W114 | W114F p.98

NL —
Eclectische mix van afgeronde 3D-panels en levendige kleur-contrasten.

FR —
Mélange éclectique de panneaux 3D arrondis et de contrastes de couleurs vives.

DE —
Eine eklektische Mischung aus abgerundeten 3D-Paneele und lebhaften Farbkontrasten.

ES —
Mezcla ecléctica de paneles 3D con formas redondeadas y vivos contrastes de color.

Each room a vibrant canvas with 3D textured walls, daringly immersive. We invite you to dive in and explore.

¹ W110 p.96



¹ W110 p.96

¹ W110 p.96



NL —
Elke kamer wordt een levendig canvas met 3D-textuurwanden. Gedurfd en meeslepend. We nodigen je uit om je erin onder te dompelen.

FR —
Chaque pièce est une toile vibrante avec des murs 3D texturés, offrant une immersion audacieuse. Nous vous invitons à plonger dans cet univers, si vous le souhaitez.

DE —
Jeder Raum ist eine lebendige Leinwand mit beeindruckend, texturierten 3D-Wänden. Wir laden Sie ein, einzutauchen, wenn Sie möchten.

ES —
Cada habitación es un lienzo vibrante con paredes texturizadas en 3D, atrevidamente envolventes. Te invitamos a sumergirte, si quieres.



Uncut modern

Unexpected possibilities

NL —

We zijn voortdurend geraakt door de bijzondere prestaties van de moderne tijd. De vooruitstrevendheid van de geest. De manier waarop bescheidenheid samenvloeit met subtiele grootsheid. We volgen met liefde strakke lijnen, hechten waarde aan minimalistische elegantie en brutalistische durf. Onze liefde voor moderniteit stimuleert ons oog voor detail.

DE —

Wir sind immer wieder von den einzigartigen Errungenschaften der Moderne bewegt. Die Fortschrittlichkeit des Geistes. Die Art und Weise, wie sich Bescheidenheit mit subtiler Erhabenheit verbindet. Wir ziehen liebevoll klare Linien nach, schätzen minimalistische Anmut und brachiale Verwegenheit. Unsere Vorliebe für die Moderne fördert unsere Aufmerksamkeit für Details.

FR —

Nous sommes perpétuellement émus par les réalisations singulières de l'ère moderne. La progressivité de l'esprit. La façon dont la modestie se mêle à la grandeur subtile. Nous traçons avec amour des lignes épurées, nous apprécions la grâce minimaliste et l'audace brute. Notre goût pour la modernité nous incite à soigner les détails.

ES —

No dejan de conmovernos los logros únicos de la era moderna. La mentalidad progresista. La forma en que la modestia se mezcla con una sutil grandeza. Delineamos líneas limpias, apreciamos la elegancia minimalista y la audacia brutalista. Nuestra pasión por la modernidad fomenta nuestra atención al detalle.

We are perpetually moved by the singular achievements of the modern age. The progressiveness of the mind. The way modesty blends with subtle grandeur. We lovingly trace clean lines, value minimalist grace and brutalist audacity. Our affection for modernity encourages our attentiveness to detail.

1. P9900 p.126 2. SX194 p.131 3. SX180 p.114



Sleek lines, angular shapes and minimalist elegance in modern harmony.

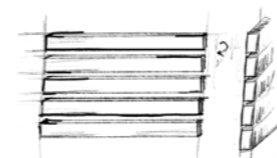

W111 BAR

NL —
Strakke lijnen, hoekige vormen en minimalistische elegantie in moderne harmonie.

FR —
Des lignes épurées, des formes anguleuses et une élégance minimaliste dans une harmonie moderne.

DE —
Schlanke Linien, kantige Formen und minimalistische Eleganz in moderner Harmonie.

ES —
Líneas depuradas, formas angulosas y elegancia minimalista en moderna armonía.



- 4. C391 p.79
- 5. C393 p.79
- 6. W111 p.101
- 7. W116 p.101
- 8. W119 p.101
- 9. CX190 p.116



ORAC

Unexpected possibilities

Modern Art Deco vibe:
an understated,
layered elegance.

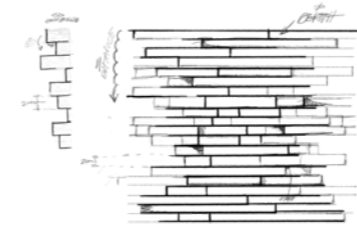

W216 MATRIX

7. C392 p.79 8. C390 p.79 9. P7070 p.126 10. SX180 p.114

- 1. C391 p.79
- 2. C393 p.79
- 3. CX190 p.130
- 4. W216 p.102
- 5. SX207 p.118

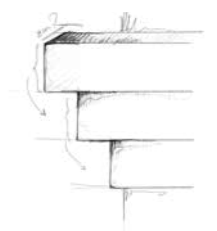

P7070

NL —
Moderne art deco vibe:
een ingetogen, gelaagde elegantie.

FR —
L'ambiance art déco moderne :
une élégance discrète et stratifiée.

DE —
Modernes Art-Déco-Gefühl:
Schlichte, vielschichtige Eleganz.

ES —
Ambiente art déco moderno:
una elegancia discreta y estratificada.

Symmetry
reimagined:
U-profiles dance on
walls and gracefully
embrace ceilings.



¹ CX190 p.116

ORAC

Unexpected possibilities

NL —
Een nieuwe vorm van symmetrie:
U-profielen dansen op muren en
omarmen sierlijk plafonds.

FR —
La symétrie revisitée : les profilés en
U dansent sur les murs et embrassent
gracieusement les plafonds.

DE —
Symmetrie neu interpretieren:
U-Profile zieren die Wände und
umfassen grazil die Decken.

ES —
Simetría reinterpretada: Los perfiles
en forma de U bailan en las paredes y
abrazan con elegancia los techos.



² CX190 | CX190F p.116



³ CX190F p.116



¹ SX180 p.114

Stepped lines
translate a modern
Art Deco vision from
floor to ceiling.

¹ SX180 p.114 ² CX188 p.00 ³ C393 p.79 ⁴ C394 p.79 ⁵ C391 p.79

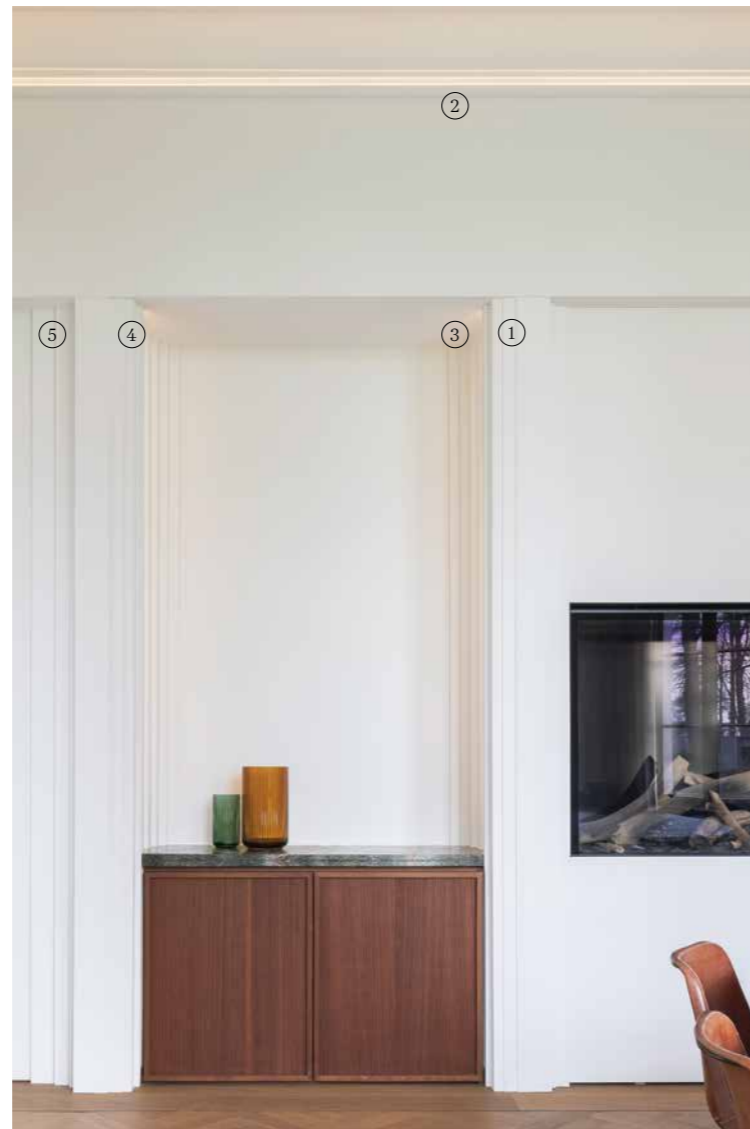

NL —
Trapsgewijze lijnen vertalen een moderne art deco visie van vloer tot plafond.

FR —
Les lignes en escalier traduisent une vision art déco moderne du sol au plafond.

DE —
Abgestufte Linien übermitteln eine moderne Art-Déco-Vision vom Boden bis zur Decke.

ES —
Las líneas escalonadas transmiten una visión art déco moderna de suelo a techo.



⁶ C991 + 2xP9900 p.77 ⁷ CX188 p.142

Vibrant allure

ORAC

Unexpected possibilities

NL —

We houden ervan om binnen te stappen in een wereld van kunstzinnige verrassingen, waar klassieke elegantie en gedurfde, gewaagde wendingen samenkomen en een unieke ervaring creëren. Een wereld van het onverwachte, waar raffinement en eigenzinnigheid samensmelten in een feest van creativiteit.

FR —

Nous aimons explorer un univers d'art surprenant, mêlant l'élégance classique à l'audace pour créer une expérience unique. Un royaume imprévisible, où sophistication et fantaisie se rencontrent pour célébrer la créativité.

DE —

Wir lieben es, in eine Welt voller kunstvoller Überraschungen einzutauchen, in der klassische Eleganz auf gewagte, mutige Wendungen trifft und ein einzigartiges Erlebnis schafft. Ein Reich des Unerwarteten, in dem Eleganz auf Fantasie trifft, um die Kreativität zu feiern.

ES —

Nos encanta adentrarnos en un mundo de sorpresas artísticas, donde la elegancia clásica se une a giros atrevidos y audaces, creando una experiencia única. Un reino de lo inesperado, donde la sofisticación se une al capricho en una celebración de la creatividad.

We love to step into a world of artful surprises, where classic elegance meets daring, audacious twists, creating a one-of-a-kind experience. A realm of the unexpected, where sophistication meets whimsy in a celebration of creativity.

1. C332 p.74 2. W214 p.96 3. W215 p.96 4. SX138 p.113

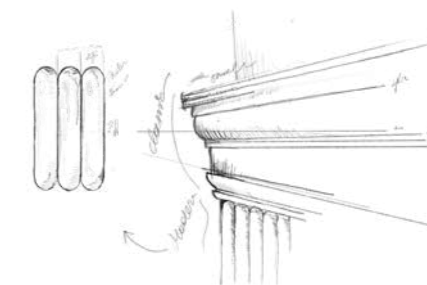

C332 NOBLESSE
W214 HILL BEAD XL

NL —
Een ondeugende botsing van textuur en kleur; levendige patronen en diepe tinten die onverwacht in harmonie zijn.

FR —
Une collision espiègle de textures et de couleurs; des motifs vibrants et des teintes profondes créant une harmonie inattendue.

DE —
Eine originelle Verbindung von Textur und Farbe; lebendige Muster und tiefe Farbtöne, die eine unerwartete Harmonie bilden.

ES —
Una traviesa colisión de texturas y colores; motivos vibrantes y tonos profundos que crean una armonía inesperada.

A mischievous collision of texture and colour; vibrant patterns and deep hues crafting an unexpected harmony.



1. C332 p.74 2. W215 p.96 3. SX138 p.113 4. W214 p.96 5. W110 p.96 6. PX209F p.131 7. WX210F p.95 8. WX211F p.95



2. W215 p.96 3. SX138 p.113 4. W214 p.96



Walls oozing with glamour and abundance, beckoning you into their captivating design narrative.

NL — Muren die bol staan van glamour en overvloed, en je meenemen in hun boeiende designverhaal.

FR — Des murs qui débordent de glamour et d'abondance et qui vous invitent à entrer dans leur récit captivant.

DE — Wände, die vor Glamour und Pracht nur so strotzen und Ihnen eine fesselnde Designgeschichte erzählen.

ES — Paredes repletas de glamur y abundancia, que invitan a adentrarse en su cautivadora narrativa de diseño.



¹ PX175 p.129 ² P8030 p.124

NL—
Een contrasterend tafereel: waar sierlijke details en serene tinten zich gedurfd manifesteren.

FR—
Un tableau de contrastes où les détails ornementaux et les teintes sereines s'expriment avec audace.

DE—
Ein Schauspiel der Kontraste, auf dem kunstvolle Details und ruhige Farbtöne gekonnt kombiniert werden.

ES—
Un lienzo de contrastes: donde los detalles ornamentales y los tonos serenos encuentran una relación atrevida.

A canvas of contrast:
where ornate details
and serene hues find
daring expression.



¹ PX175 p.129 ² P8030 p.124



³ P3020 p.125 ⁴ P3020A p.133 ⁵ P8050 p.124



1- PX120 p.129 2- P4020 p.124



3- C305 p.70 4- C307A p.70 5- C211 p.70

Untamed creativity
blooms in a lavish
fusion of colour and
intricate design.



1- PX120 p.129 2- P4020 p.124 3- C305 p.70 4- C307A p.70 5- C211 p.70 6- DX170-2300 p.154 7- D330LR p.154

NL—
Ongetemde creativiteit bloeit in een uitbundige samensmelting van kleuren en complexe ontwerpen.

FR—
La créativité sauvage s'épanouit dans une somptueuse fusion de couleurs et de motifs complexes.

DE—
Unbändige Kreativität erblüht in einer großartigen Verschmelzung von Farbe und kunstvollem Design.

ES—
La creatividad indómita florece en una fastuosa fusión de color y diseño intrincado.

Whenever you fancy a change,
our products are ready for
a repaint.



1- PX120 p.129 2- P4020 p.124 3- C305 p.70 4- C307A p.70 5- C211 p.70

NL —
Als je zin hebt in verandering,
dan laten onze producten zich
makkelijk herschilderen.

FR —
Quand vous avez envie de changer,
nos produits sont prêts à être repeints.

DE —
Wann immer Sie Lust auf eine Ver-
änderung haben, sind unsere Produkte
bereit für einen neuen Anstrich.

ES —
Cada vez que desees un cambio,
nuestros productos eran listos para
una transformación cromática.



Essential still

ORAC

Unexpected possibilities

We love to embrace the timeless charm of bygone eras as it speaks fluently in the language of today. A demonstration of how classic forms can be reinterpreted to remain ever-relevant.

NL —

We houden er zo van wanneer de tijdloze charme van vervlogen tijden vloeiend spreekt in de taal van vandaag. Een demonstratie van hoe klassieke vormen kunnen worden geherinterpreteerd om altijd relevant te blijven.

FR —

Nous apprécions que le charme intemporel des époques révolues puisse s'exprimer naturellement dans le langage contemporain. Une démonstration de la manière dont les formes classiques peuvent être réinterprétées pour rester toujours pertinentes.

DE —

Wir lieben es, wenn der zeitlose Charme vergangener Epochen fließend in die Sprache von heute übergeht. Eine Demonstration, wie klassische Formen neu interpretiert werden können, um immer aktuell zu bleiben.

ES —

Nos fascina cuando el encanto atemporal de épocas pasadas habla con fluidez el lenguaje de hoy. Una demostración de cómo las formas clásicas pueden reinterpretarse para seguir siendo siempre actuales.

1- C343 p.66 2- P8020 p.124 3- P4020 p.124 4- SX206 p.113



NL—
Verfijnde elementen in een alles-
behalve willekeurige volgorde op de
muur stralen evenwicht en rust uit.

FR—
Des éléments raffinés, disposés sur
le mur dans un ordre qui n'a rien
d'arbitraire, dégagent un équilibre
et une présence tranquille.

DE—
Edle Elemente in einer alles andere als
willkürlichen Reihenfolge an der Wand
wirken ausgewogen und doch präsent

ES—
Elementos sofisticados dispuestos en
una secuencia cuidadosamente diseña-
da que irradia equilibrio y tranquilidad.

C343 HERITAGE

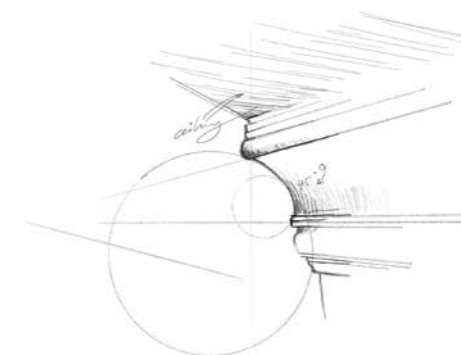

Refined elements,
in a far from arbitrary
sequence on the wall,
exude balance and
discrete presence.





ORAC

Unexpected possibilities

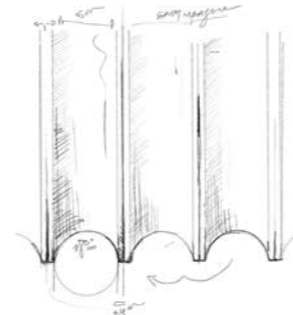

W109 VALLEY

Poised grace in every line,
creating an atmosphere of
calm sophistication.

1. W109 p.98 2. P9010 p.124 3. P9050 p.126



1. W109 p.98 2. P9010 p.124 3. P9050 p.126 4. SX155 p.112

NL —
Strakke elegantie in elke lijn die een
sfeer van kalme verfijning creëert.

FR —
Une grâce suspendue dans chaque
ligne, créant une atmosphère de
calme et de sophistication.

DE —
Jede Linie vermittelt eine gelassene
Anmut und schafft eine Atmosphäre
von ruhiger Raffinesse.

ES —
Elegancia equilibrada en cada línea,
creando un ambiente de sofisticada
serenidad.

Towering ceilings crowned with grand cornices offer a narrative of timeless opulence.



1. P8050 p.124



3. C305 p.70 4. C307A p.70 5. C211 p.70

2. PX175 p.129 3. C305 p.70 4. C307A p.70 5. C211 p.70 6. P8030 p.124 7. SX191 p.115



NL — Toren hoge plafonds bekroond met grote kroonlijsten vertellen een verhaal van tijdloze weelde.

FR — Les hauts plafonds couronnés de grandes corniches offrent une image d'opulence intemporelle.

DE — Hoch ragende Decken, gekrönt von prächtigen Stuckleisten, vermitteln einen Eindruck von zeitloser Opulenz.

ES — Los altísimos techos coronados con grandes cornisas ofrecen un relato de opulencia atemporal.



1

2

3

4

5

6

Grandeur in every detail, framed by a bold monochromatic use of saturated colours.

1. C343 p.66 2. P8020 p.124 3. P4020 p.124 4. SX191 p.115 5. DX170-2300 p.154 6. D330LR p.154



1

2

3

4

1. C343 p.66 2. P8020 p.124 3. P4020 p.124 4. SX191 p.115

NL — Grandeur in elk detail, omlijst door een gedurfd monochroom gebruik van verzadigde kleuren.

FR — La grandeur dans chaque détail, encadrée par une utilisation monochromatique audacieuse de couleurs saturées.

DE — Jedes Detail wirkt prachtvoll und wird von einer kühnen monochromen Verwendung gesättigter Farben eingerahmt.

ES — Grandeza en cada detalle, enmarcado por un atrevido uso monocromático de colores saturados.

¹ P8030 p.124 ² CX160 p.89 ³ C332 p.74



Enhance our products with textured paint for an artisanal finish that adds depth and character to any room.

NL —
Je kan het design van onze producten kracht bijzetten met textuurverf voor een artisanale look die diepgang en karakter aan elke ruimte geeft.

FR —
Rehaussez nos produits avec de la peinture texturée pour une finition artisanale qui ajoute de la profondeur et du caractère à n'importe quelle pièce.

DE —
Veredeln Sie unsere Produkte mit Strukturfarbe für ein handwerkliches Finish, das jedem Raum Tiefe und Charakter verleiht.

ES —
Eleva nuestros productos con pintura texturizada para un acabado artesanal que aporta profundidad y carácter a cualquier habitación.



Products

Discover our architectural elements, made for walls. Every product is an innovation with user ease in mind, designed to enhance and transform interiors. We propose a palette that matches styles and meets ideas. So that your walls can become the canvas for your imagination.

NL –

We stellen u graag voor aan onze architecturale elementen, ontworpen voor muren. Elk product is een innovatie met gebruiksgemak in het achterhoofd, ontworpen om interieurs kracht bij te zetten. We leggen een palet voor dat bij stijlen aansluit en ideeën tegemoet komt. Zodat je muren het canvas voor je verbeelding kunnen worden.

FR –

Nous vous invitons à découvrir nos éléments architecturaux, faits pour les murs. Chaque produit est une innovation qui vise à faciliter la vie de l'utilisateur, conçu pour améliorer et transformer vos intérieurs. Nous proposons une palette qui s'harmonise avec les styles et répond aux idées. Pour que vos murs deviennent la toile de votre imagination.

DE –

Entdecken Sie unsere architektonischen Elemente für Ihre Wände. Jedes Produkt ist eine Innovation. Entwickelt für Nutzerfreundlichkeit, um Innenräume zu bereichern und zu verwandeln. Wir präsentieren eine Produktreihe, die zu jedem Stil passt und Ideen verwirklicht. Damit Ihre Wände zu einer Leinwand für Ihre Fantasie werden können.

ES –

Descubre nuestros elementos arquitectónicos creados para paredes. Cada producto es innovador, y esta pensado para facilitar su uso y diseñado para transformar interiores. Proponemos una paleta que armoniza con distintos estilos y satisface tus ideas. Así, tus paredes pueden convertirse en el lienzo de tu imaginación.



Materials

In-house engineered material compositions

INGENIEUZE MATERIALEN
MATÉRIAUX TECHNIQUES
DURCHDACHTE MATERIALEN
MATERIALES DE INGENIERÍA



PUROTOUCH®

A high-quality, medium-density polyurethane that allows fine details.

Een kwalitatieve polyurethaan van hoge densiteit die scherpe details mogelijk maakt — Un polyuréthane de qualité à haute densité qui permet de créer des détails fins — Ein qualitativ hochwertiges Polyurethan hoher Dichte, das schöne Details möglich macht — Poliuretano de alta densidad y calidad con el que crear ambientes exclusivos.

Detail Design ☆☆☆

Impact Resistance ☆☆☆

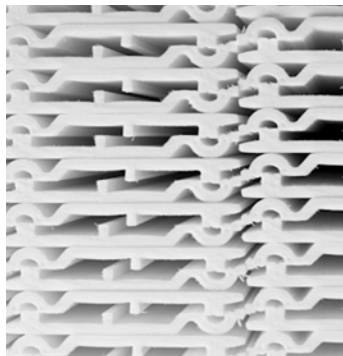

DUROPOLYMER®

An extruded and impact-resistant polymer based on a high-density polystyrene.

Geëxtrudeerde en impactbestendige polystyreenmix van hoge densiteit — Un polymère extrudé résistant aux impacts à base d'un mélange de polystyrènes haute densité — Extrudierter und schlagfester, hochdichter Polystyrol-Mix — Polímero fabricado por extrusión, resistente a impactos fuertes a base de una mezcla de poliestireno de alta densidad.

Detail Design ☆☆☆

Impact Resistance ☆☆☆



DUROFOAM®

An extruded lightweight polymer based on a low-density polystyrene blend.

Geëxtrudeerde lichtgewicht polystyreenmix van medium densiteit — Un polymère léger extrudé à base d'un mélange de polystyrènes de densité moyenne — Extrudiertes, leichtes Polymer auf der Grundlage eines Polystyrol-Mix mittlerer Dichte — Polímero fabricado por extrusión de peso ligero a base de una mezcla de poliestireno de densidad baja.

Detail Design ☆☆☆

Impact Resistance ☆☆☆



FLEX

A quality high-density flexible polyurethane.

Een kwalitatieve flexibele polyurethaan van hoge densiteit — Un polyuréthane flexible de haute densité et qualité — Ein hochwertiger, hochdichter flexibles Polyurethanschaum — Poliuretano moldeado flexible de alta calidad y densidad.

Detail Design ☆☆☆

Impact Resistance ☆☆☆

READY TO PAINT

All of our products are ready to paint. Coloured end finishes on demand.

Al onze producten worden schilderklaar geleverd. Kleuren op aanvraag — Tous nos produits sont prêts à peindre. Couleurs sur demande — Alle unsere Produkte sind bereit zum Beschichten. Farben auf Anfrage — Todos nuestros productos están listos para ser pintados. Colores bajo demanda.



VOORDELEN
AVANTAGES
VORTEILE
VENTAJAS

Advantages



DURABLE

Orac products are designed to last a lifetime. Smart design and high-end technology assure strong and water resistant products.

Orac producten zijn ontwikkeld om een leven lang mee te gaan. Slim productdesign en state-of-the-art technologie verzekeren sterke en waterbestendige producten — Les produits sont conçus pour durer toute une vie. Une conception intelligente et une technologie haut de gamme garantissent des produits robustes et résistants à l'eau — Orac-Produkte halten ein Leben lang. Intelligentes Design und hochwertige Technologie sorgen für robuste und absolut wasserbeständige Produkte — Los productos de Orac están diseñados para durar toda la vida. Gracias a su diseño sofisticado y la tecnología de vanguardia, se trata de productos sólidos y resistentes al agua.

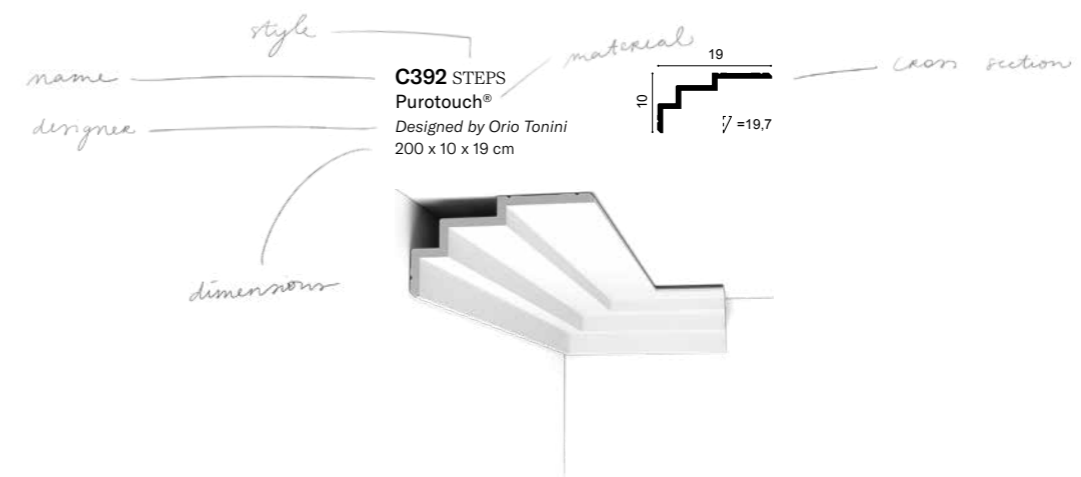

Legend

At Orac, our vision is to become restorative by 2050. This ambitious goal drives our material choices and operational practices, ensuring that every step we take not only minimizes environmental harm but actively contributes to ecological restoration. Since 2018 we have been making profound changes in the full lifecycle of our products. From selection and use of raw materials all the way to our production process.

— There are many sides to walls. We go for the good side.

NL —
 Bij Orac is het de visie om restoratief te worden tegen 2050. Dit ambitieuze doel is de drijfveer van onze materiaalkeuzes en operationele praktijken en zorgt ervoor dat elke stap die we zetten niet alleen schade aan het milieu beperkt, maar ook actief bijdraagt aan ecologisch herstel. Sinds 2018 hebben we ingrijpende veranderingen doorgevoerd in de volledige levenscyclus van onze producten. Van de selectie en het gebruik van grondstoffen en materialen tot aan ons productieproces. — Muren hebben vele kanten. Wij gaan voor de goede kant.

FR —
 Chez Orac, notre vision est de devenir réparateur d'ici à 2050. Cet objectif ambitieux oriente nos choix de matériaux et nos pratiques opérationnelles, en veillant à ce que chaque mesure que nous prenons non seulement minimise les dommages à l'environnement, mais contribue aussi activement à la restauration écologique. Depuis 2018, nous avons fait de changements profonds au cycle de vie complet de nos produits. De la sélection et de l'utilisation des matières premières jusqu'à notre processus de production. — Les murs ont beaucoup de côtés. Nous choisissons le bon côté.

DE —
 Orac hat die Vision, bis zum Jahr 2050 restaurativ zu werden. Dieses ehrgeizige Ziel treibt unsere Materialauswahl und betriebliche Praktiken, um sicherzustellen dass jeder Schritt, den wir unternehmen, nicht nur den Schaden für die Umwelt minimiert, sondern aktiv zur ökologischen Wiederherstellung beiträgt. Seit 2018 haben wir tiefgreifende Veränderungen im gesamten Lebenszyklus unserer Produkte vorgenommen. Von der Auswahl und Verwendung von Rohstoffen bis hin zu unserem Produktionsprozess. — Eine Wand hat viele Seiten. Wir entscheiden uns für die gute Seite.

ES —
 En Orac, nuestro objetivo es llegar a tener un impacto positivo en 2050. Este ambicioso objetivo impulsa nuestra elección de materias primas y procedimientos operativos, garantizando que cada paso que damos no solo minimiza el daño medioambiental, sino que contribuye a la restauración ecológica. A partir de 2018 hemos estado realizando cambios significativos en el ciclo de vida de nuestros productos, desde la selección y el uso de materias primas hasta nuestro proceso de producción. — Las paredes tienen muchas caras. Nosotros nos decantamos por la buena.



BIOCIRCULAR MATERIALS
 Orac's designs merge recycled and bio-based materials, emphasizing sustainable innovation.



SUSTAINABLE OPERATIONS
 Orac has been CO₂ neutral since 2021, working towards climate positivity by 2050.



BUILT TO LAST, BUILT RESPONSIBLY
 Our durable products with a lasting lifetime support a sustainable, circular economy.



MORE THAN WALLS
 Orac's commitment to sustainability extends to community engagement and social responsibility.

Product overview

- 01 Cornice mouldings
- 02 3D Wall covering
- 03 Skirting boards
- 04 Panel mouldings
- 05 Indirect lighting
- 06 Deco elements
- 07 The perfect finish
- 08 Flexible products



01 p. 64

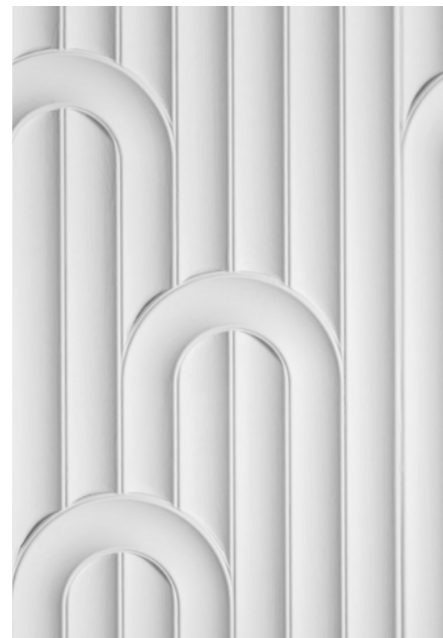

02 p. 92



03 p. 108



04 p. 122



05 p. 134



06 p. 148



07 p. 158

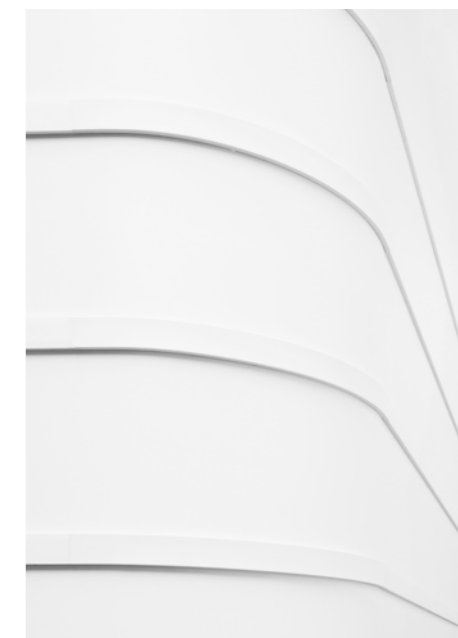

08 p. 162

Cornice Mouldings

ORAC

Products

01

KROONLIJSTEN
CORNICHES
STUCKLEISTEN
CORNISAS

It truly does move us when we look up and see how it softens the strict transition between wall and ceiling. For us, a cornice is about attention to detail, be it from ornate to subtle. We have thought them all through so that there should always be an option that meets your personal aspirations.

NL –
Omhoog kijken en zien hoe de overgang tussen muur en plafond verzacht wordt. Dat beroert ons. Voor ons draait een kroonlijst om aandacht voor detail. Van sierlijk tot subtiel. Elk design goed doordacht zodat er altijd een optie is die aansluit op je persoonlijke wensen.

FR –
C'est véritablement captivant. En levant les yeux, on remarque comment elle adoucit la transition stricte entre le mur et le plafond. Pour nous, une corniche incarne un souci minutieux du détail, que ce soit dans l'ornementation ou dans la subtilité. Chaque option a été soigneusement pensée pour répondre à vos aspirations personnelles.

DE –
Das bewegt uns wahrhaftig: Wenn wir nach oben schauen und sehen, wie der harte Übergang zwischen Wand und Decke aufgelockert wird. Für uns ist ein Gesims eine Frage der Liebe zum Detail. Von verschnörkelt bis dezent. Wir haben sie alle berücksichtigt. Daher sollte es immer eine Möglichkeit geben, die Ihren persönlichen Ansprüchen entspricht.

ES –
Es realmente conmovedor cuando miramos hacia arriba y vemos cómo suaviza la estricta transición entre pared y techo. Para nosotros, una cornisa es sinónimo de atención al detalle. De lo ornamentado a lo sencillo. No hemos dejado nada al azar, para que siempre haya una opción que satisfaga tus deseos.

C341 | C341F HERITAGE
Purotouch®
200 x 8,8 x 12,2 cm

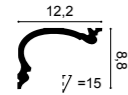

C342 HERITAGE
Purotouch®
200 x 14 x 19 cm

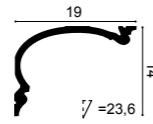

C343 HERITAGE
Purotouch®
200 x 19 x 25 cm

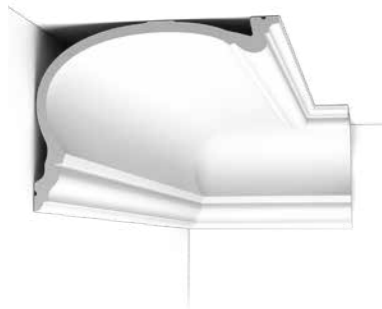
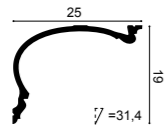

C344 HERITAGE
Purotouch®
200 x 27,3 x 35 cm

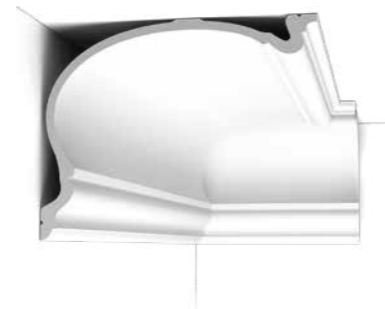
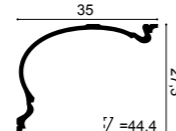

¹ C343 ² P8020 p.124



Cornice moldings

¹ C327 ² P8030 p.124 ³ P8020 p.124 ⁴ SX191 p.115

C325 MANOIR
Purotouch®
200 x 7 x 6,5 cm

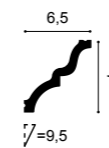

C326 MANOIR
Purotouch®
200 x 10,5 x 9 cm

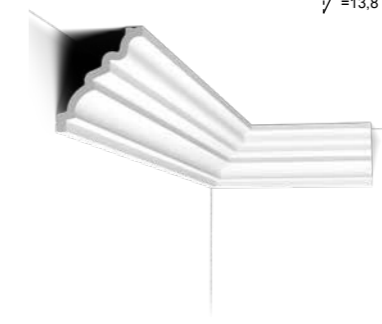
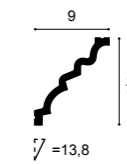

C327 MANOIR
Purotouch®
200 x 14,3 x 15,9 cm

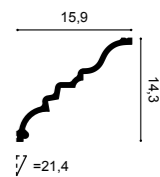

C338 BA'ROCK
Purotouch®
200 x 18,2 x 18,2 cm

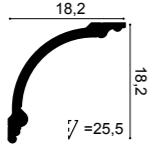

C338A BA'ROCK
Purotouch®
200 x 18,2 x 18,2 cm
Dessin: 120 cm

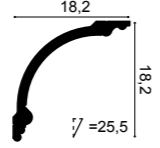

C338B BA'ROCK
Purotouch®
200 x 18,2 x 18,2 cm
Dessin: 2 x 57 cm

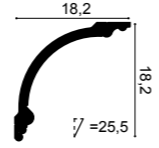

C336 BA'ROCK
Purotouch®
200 x 27,1 x 26,6 cm

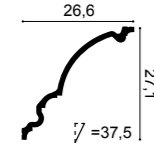

1. C217



C230 | C230F
Purotouch®
200 x 2,9 x 2,9 cm

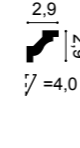

C215 | C215F
Purotouch®
200 x 4,7 x 4,7 cm

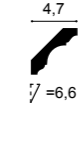

C322
Purotouch®
200 x 5 x 4,2 cm

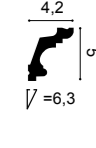

C200
Purotouch®
200 x 6,5 x 5,7 cm

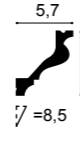

C220 | C220F
Purotouch®
200 x 7,6 x 11,6 cm



C213 | C213F
Purotouch®
200 x 8 x 8 cm

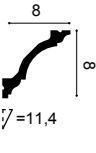

① **C217 | C217F**
Purotouch®
200 x 15,6 x 10,3 cm



C217 | C217F ↻ 90°
Purotouch®
200 x 10,3 x 15,6 cm

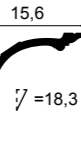

C216
Purotouch®
200 x 11,6 x 13,3 cm

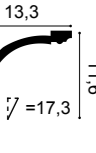

C301
Purotouch®
200 x 17 x 14,4 cm



C305
Purotouch®
200 x 4,7 x 15,5 cm

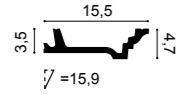

C305 + C213

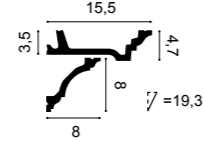

C305 + C211

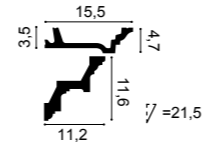

C211 | C211F
Purotouch®
200 x 11,6 x 11,2 cm

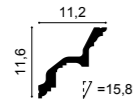

C422
Purotouch®
200 x 16,4 x 19,4 cm

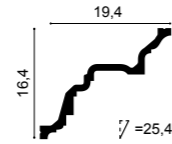

C307
Purotouch®
200 x 19,5 x 19,5 cm

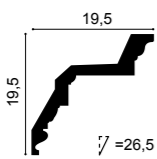

(A) C307 + C307A (B)
Purotouch®
Duropolymer®
C307A: 7,5 x 4 x 9,4 cm

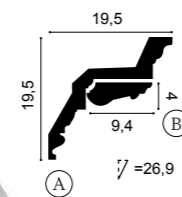

Cornice moldings

1. PX175 p.129 2. C305 3. C307A 4. C211 5. P8030 p.124 6. SX191 p.115



1. C219

C333 | C333F
Purotouch®
200 x 12,2 x 11,1 cm

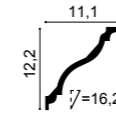

C331 | C331F
Purotouch®
200 x 6,4 x 13,5 cm

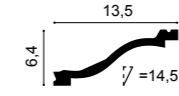

C334 | C334F
Purotouch®
200 x 15 x 19,6 cm

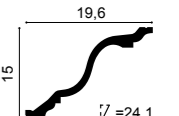

C902 | C902F
Purotouch®
200 x 10,3 x 10,3 cm

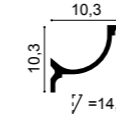

C901 | C901F
Purotouch®
200 x 14,8 x 12,4 cm



C900
Purotouch®
200 x 17,1 x 14,6 cm

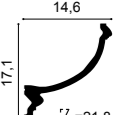

C212
Purotouch®
200 x 7,5 x 4,5 cm

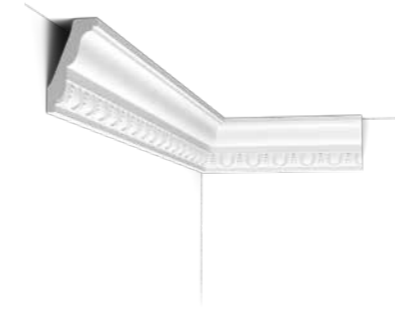
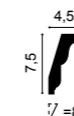

C201
Purotouch®
200 x 11,6 x 4,8 cm

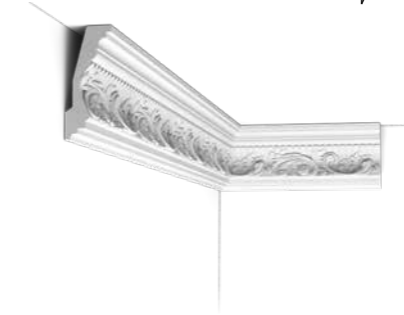
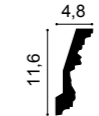

C304 | C304F
Purotouch®
200 x 12,2 x 7,2 cm

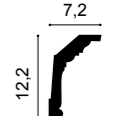

C303
Purotouch®
200 x 14,4 x 6,5 cm

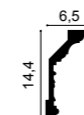

1. **C219**
Purotouch®
200 x 17,6 x 13 cm

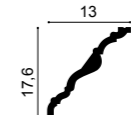

C321 | C321F
Purotouch®
200 x 9,9 x 5 cm

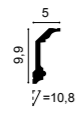

C339 | C339F
Purotouch®
200 x 14,1 x 6,4 cm

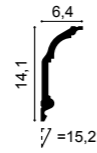

C332
Purotouch®
200 x 23 x 11,4 cm

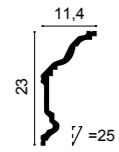

C332 90°
Purotouch®
200 x 11,4 x 23 cm

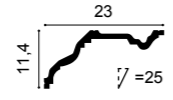

C340
Purotouch®
200 x 25,6 x 13,5 cm

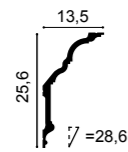

C340 90°
Purotouch®
200 x 13,5 x 25,6 cm

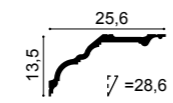

1. C332 2. P8020 p.124 3. SX118 p.111



Cornice moldings

the perfect finish



PG. 158-161

C250 | C250F
Purotouch®
200 x 1,6 x 1,6 cm

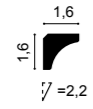

C260
Purotouch®
200 x 4,1 x 4,8 cm

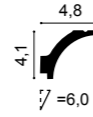

C240 | C240F
Purotouch®
200 x 8 x 8 cm

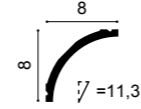

¹ C990 + 2x CX188 p.142



C991
Purotouch®
200 x 14 x 11 cm
Designed by Ulf Moritz

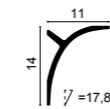

C991 + P9900

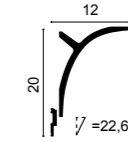

C991 + 2x P9900

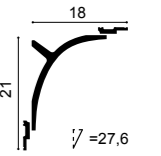

¹ C991 90°
Purotouch®
200 x 11 x 14 cm
Designed by Ulf Moritz

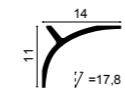

C991 + P9900 90°

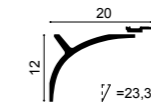

C991 + 2x P9900 90°

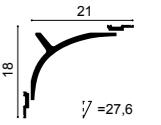

C990 INFINITY
Purotouch®
200 x 21,6 x 15,9 cm
Designed by Xavier Donck

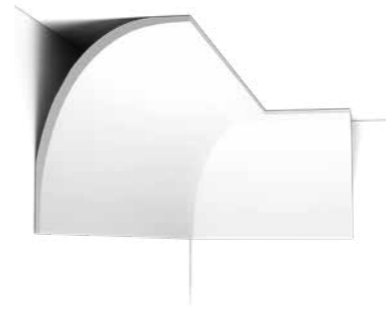
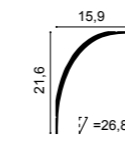

C990 + P9900

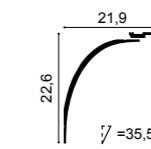

C990 + 2x P9900

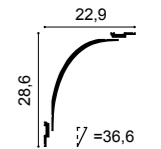

C990 INFINITY 90°
Purotouch®
200 x 15,9 x 21,6 cm
Designed by Xavier Donck

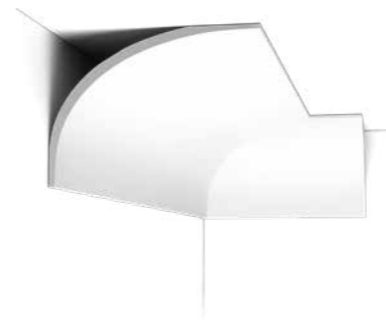
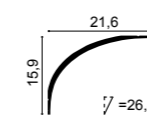

C990 + P9900 90°

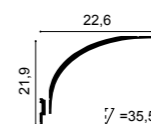

C990 + 2x P9900 90°

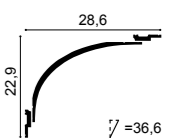

Steps

ORAC

Products

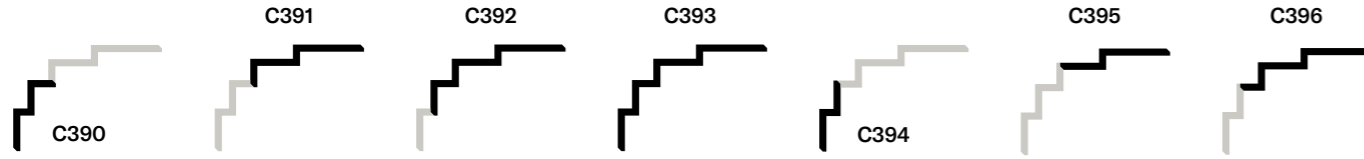

C394 STEPS
Purotouch®
200 x 9,5 x 3,1 cm
Designed by Orio Tonini

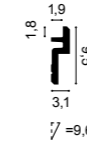

C395 STEPS
Purotouch®
200 x 15,5 x 3,1 cm
Designed by Orio Tonini



C396 STEPS
Purotouch®
200 x 18,5 x 6,1 cm
Designed by Orio Tonini

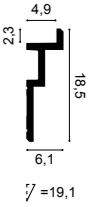

CORNICE MOULDINGS | KROONLIJSTEN | CORNICHES | STUCKLEISTEN | CORNISAS

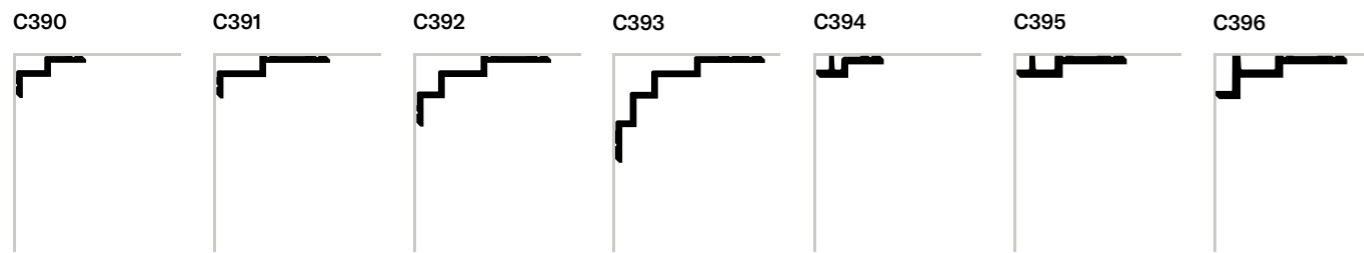

C390 STEPS
Purotouch®
200 x 6 x 10 cm
Designed by Orio Tonini



C391 STEPS
Purotouch®
200 x 6 x 16 cm
Designed by Orio Tonini

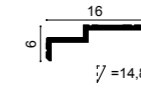

C392 STEPS
Purotouch®
200 x 10 x 19 cm
Designed by Orio Tonini

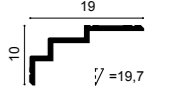

BORDER

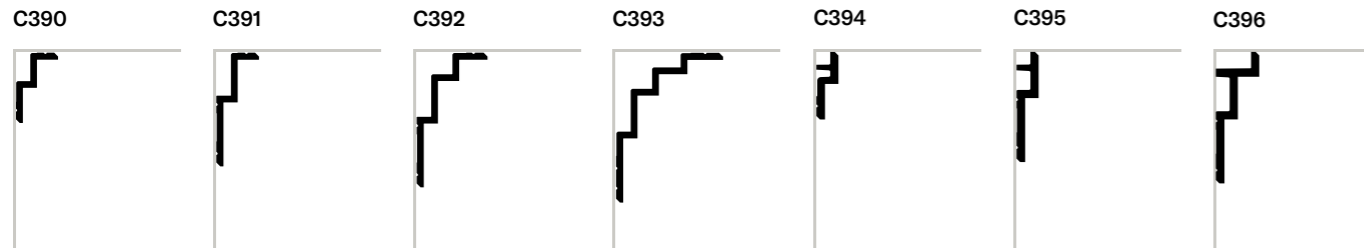

C393 STEPS
Purotouch®
200 x 15 x 21 cm
Designed by Orio Tonini

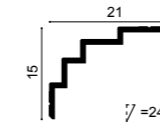

1. C391 2. C393

CURTAIN PROFILES | GORDIJNPROFIELEN | PROFILS RIDEAU | GARDINENLEISTEN | CORNISAS PARA CORTINAS

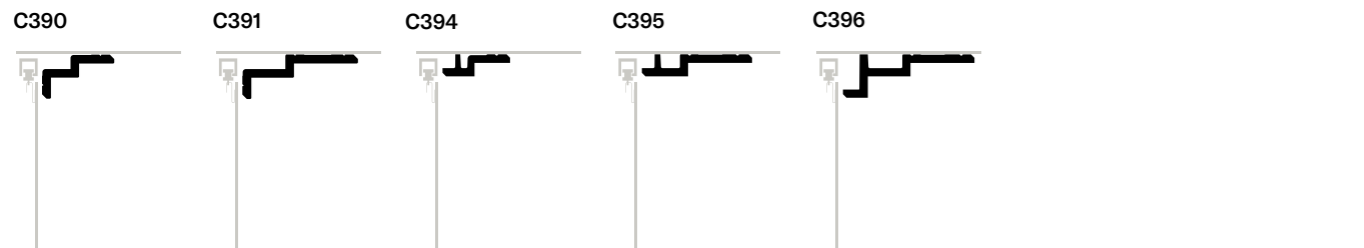

LED COVING | INDIRECTE VERLICHTING | ÉCLAIRAGE INDIRECT | INDIREKTE BELEUCHTUNG | ILUMINACIÓN INDIRECTA



Downlighter

Uplighter



Cornice mouldings

C360
Purotouch®
200 x 2,1 x 6 cm
Designed by Jacques Vergracht

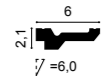

C356
Purotouch®
200 x 2 x 10 cm
Designed by Jacques Vergracht

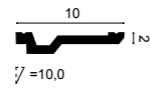

C355
Purotouch®
200 x 3,5 x 11,1 cm
Designed by Jacques Vergracht

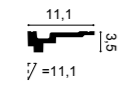

C353
Purotouch®
200 x 3 x 16,5 cm
Designed by Jacques Vergracht

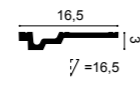

C354
Purotouch®
200 x 4 x 21,5 cm
Designed by Jacques Vergracht

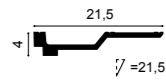

C602
Purotouch®
200 x 5,3 x 5 cm
Designed by Jacques Vergracht



C400
Purotouch®
200 x 6 x 10 cm
Designed by Jacques Vergracht

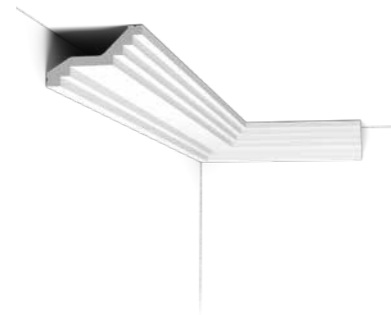

¹ C355 ² C991 p.77

Curtain profiles

GORDIJNPROFIELEN
 PROFILS RIDEAU
 GARDINENLEISTEN
 CORNISAS PARA CORTINAS



1. C340

ORAC

Products

**C394 STEPS
 CURTAIN PROFILE**
 Purotouch®
 200 x 3,1 x 9,5 cm
 Designed by Orlo Tonini

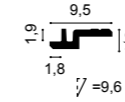

**C395 STEPS
 CURTAIN PROFILE**
 Purotouch®
 200 x 3,1 x 15,5 cm
 Designed by Orlo Tonini

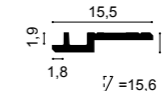

**C390 STEPS
 CURTAIN PROFILE**
 Purotouch®
 200 x 6 x 10 cm
 Designed by Orlo Tonini

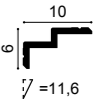

**C391 STEPS
 CURTAIN PROFILE**
 Purotouch®
 200 x 6 x 16 cm
 Designed by Orlo Tonini

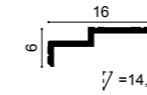

**C396 STEPS
 CURTAIN PROFILE**
 Purotouch®
 200 x 6,1 x 18,5 cm
 Designed by Orlo Tonini

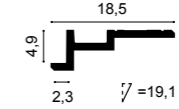

**C991
 CURTAIN PROFILE**
 Purotouch®
 200 x 11 x 14 cm
 Designed by Ulf Moritz

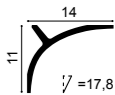

**C341 | C341F HERITAGE
 CURTAIN PROFILE**
 Purotouch®
 200 x 8,8 x 12,2 cm

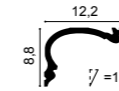

**C342 HERITAGE
 CURTAIN PROFILE**
 Purotouch®
 200 x 14 x 19 cm

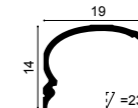

**C343 HERITAGE
 CURTAIN PROFILE**
 Purotouch®
 200 x 19 x 25 cm

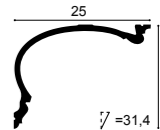

1. **C340
 CURTAIN PROFILE**
 Purotouch®
 200 x 13,5 x 25,6 cm

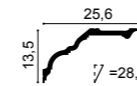

**CX196 U-STEPS
 CURTAIN PROFILE**
 Duropolymer®
 200 x 4 x 11,3 cm
 Designed by Orlo Tonini



**CX197 U-STEPS
 CURTAIN PROFILE**
 Duropolymer®
 200 x 5 x 9,3 cm
 Designed by Orlo Tonini



Cornice mouldings

CX124 | CX124F
Duropolymer®
200 x 4,9 x 4,9 cm

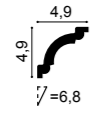

CX100 | CX100F
Duropolymer®
200 x 6,9 x 7,1 cm

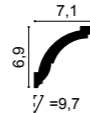

CX123 | CX123F
Duropolymer®
200 x 8 x 8 cm

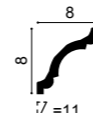

③ CX111
Duropolymer®
200 x 2,6 x 1,5 cm



CX110 | CX110F
Duropolymer®
200 x 4,5 x 4,1 cm

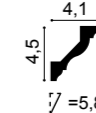

CX127 | CX127F
Duropolymer®
200 x 9,4 x 9,4 cm

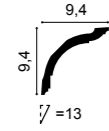

CX199 | CX199F
Duropolymer®
200 x 8 x 8 cm

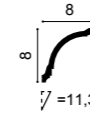

CX106 | CX106F
Duropolymer®
200 x 11,8 x 11,7 cm

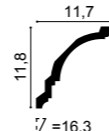

CX108
Duropolymer®
200 x 5,4 x 5,5 cm

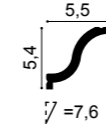

CX112
Duropolymer®
200 x 5,4 x 3,8 cm

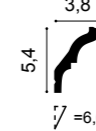

CX177
Duropolymer®
200 x 7 x 6 cm



1. P8030 p.124 2. P8020 p.124 3. CX110

CX203
Duropolymer®
200 x 14,5 x 14,5 cm

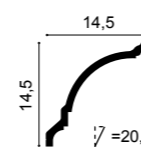

CX129
Duropolymer®
200 x 9,4 x 9,4 cm

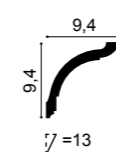

CX107
Duropolymer®
200 x 11,8 x 11,7 cm

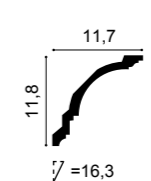

the perfect finish



CX133
Duropolymer®
200 x 2 x 2 cm



CX132
Duropolymer®
200 x 2 x 2 cm



CX115
Duropolymer®
200 x 3 x 2,9 cm



① **CX190 | CX190F U-PROFILE**
Duropolymer®
200 x 2 x 3 cm
Designed by Orio Tonini

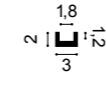

CX109 | CX109F
Duropolymer®
200 x 4,4 x 4,4 cm

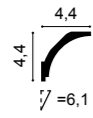

CX126
Duropolymer®
200 x 8,7 x 8,7 cm

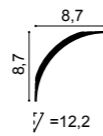

CX196 U-STEPS
Duropolymer®
200 x 11,3 x 4 cm
Designed by Orio Tonini

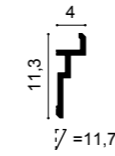

CX148
Duropolymer®
200 x 4,3 x 2,9 cm

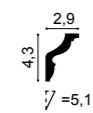

CX141
Duropolymer®
200 x 5,9 x 3,1 cm

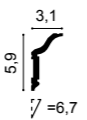

CX176
Duropolymer®
200 x 8 x 4 cm



CX197 U-STEPS
Duropolymer®
200 x 9,3 x 5 cm
Designed by Orio Tonini

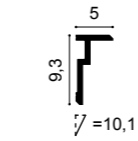

CX192
Duropolymer®
200 x 12 x 6 cm

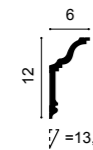

② **PX198 | PX198F U-STEPS**
Duropolymer®
200 x 8,3 x 2 cm
Designed by Orio Tonini

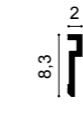

PX198 | PX198F U-STEPS 90°
Duropolymer®
200 x 2 x 8,3 cm
Designed by Orio Tonini



1. CX190F 2. PX198F 3. W111F p.101 4. W116F p.101 5. W119F p.101

¹ CX192 p.86 ² P8030 p.124



SX194 | SX194F SQUARE
Duopolymer®
200 x 1 x 2 cm



SX162 | SX162F SQUARE
Duopolymer®
200 x 1 x 4 cm



SX157 | SX157F SQUARE
Duopolymer®
200 x 1,3 x 6,6 cm

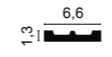

SX163 | SX163F SQUARE
Duopolymer®
200 x 1,3 x 10,1 cm

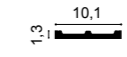

SX182 | SX182F CASCADE
Duopolymer®
200 x 1,3 x 5 cm

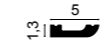

SX183 | SX183F CASCADE
Duopolymer®
200 x 1,3 x 7,5 cm

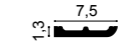

SX184 | SX184F CASCADE
Duopolymer®
200 x 1,3 x 11 cm

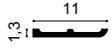

CX160
Duopolymer®
200 x 1,3 x 3,9 cm

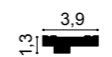

CX161
Duopolymer®
200 x 1,3 x 6,9 cm

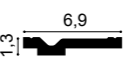

Cornice moldings

the perfect finish



PG.158-161

CB500N
Durofoam®
200 x 2,5 x 1,8 cm

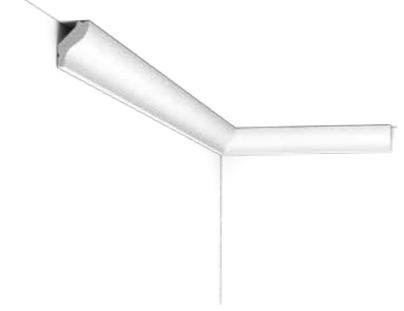
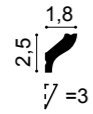

CB501N
Durofoam®
200 x 4,1 x 3,5 cm

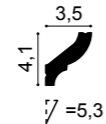

CB502N
Durofoam®
200 x 5,9 x 4,9 cm

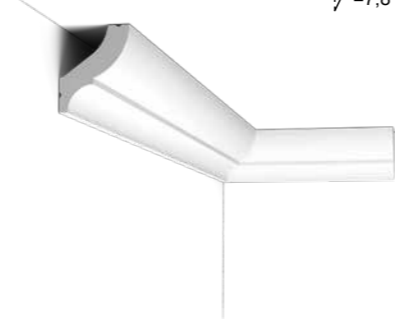
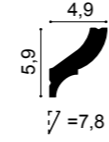

CB503N
Durofoam®
200 x 8,2 x 9,2 cm

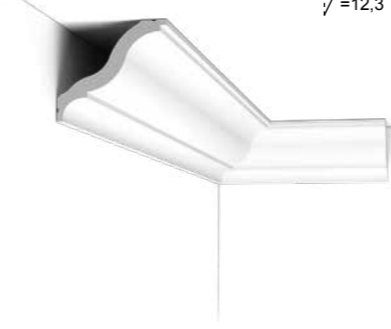
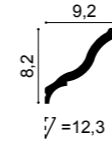

CB520N
Durofoam®
200 x 3,5 x 3,5 cm

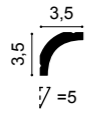

CB521N
Durofoam®
200 x 5 x 5 cm

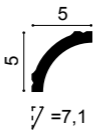

CB522N
Durofoam®
200 x 6,7 x 6,7 cm

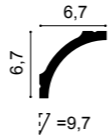

CB524N
Durofoam®
200 x 9 x 9 cm

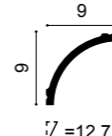

CB525N
Durofoam®
200 x 6,5 x 6 cm

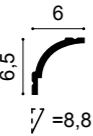

CB523N
Durofoam®
200 x 5,9 x 4,4 cm

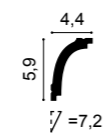

CB510N
Durofoam®
200 x 4 x 4 cm

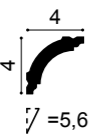

CB511N
Durofoam®
200 x 6,7 x 6,7 cm

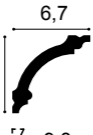

1 CB512N
Durofoam®
200 x 9 x 9 cm

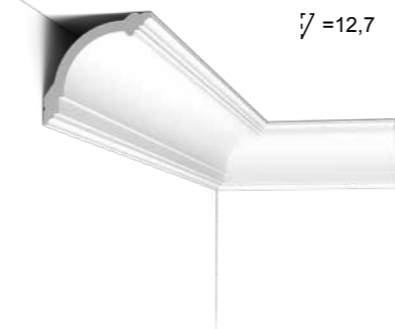
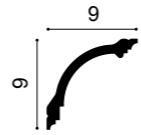

1. CB512N 2. PX103 p.129

3D Wall covering

ORAC

Products

3D WANDBEKLEDING
REVÊTEMENTS MURAUX 3D
3D WANDVERTÄFELUNG
REVESTIMIENTO DE PARED 3D

We invite you to experience the extraordinary with our 3D wall coverings. Captivating sculptural landscapes, these masterpieces redefine your walls, inviting touch and exploration. Discover a range of bold and subtle designs, each a testament to the art of interior transformation.

02

NL —
Laat je verrassen door het ongeken-
de met onze 3D wandbekleding.
Adembenemende sculpturen die
uw muren tot een nieuw leven
wekken, uitnodigend tot aanraken en
verkennen. Duik in een assortiment
van gedurfde en subtiele ontwerpen,
die stuk voor stuk blijf geven
van de vernieuwende impact op
interieurdesign.

FR —
Faites l'expérience de l'extraordinaire
avec nos revêtements muraux
3D si vous le souhaitez. Des
paysages sculpturaux captivants.
Ces chefs-d'œuvre redéfinissent
vos murs, invitant au toucher et à
l'exploration. Découvrez une gamme
de designs audacieux et subtils,
chacun témoignant de l'art de la
transformation intérieure.

DE —
Erleben Sie das Außergewöhnliche
mit unseren 3D-Wandverkleidungen.
Fesselnde skulpturale Landschaften.
Diese Meisterwerke definieren Ihre
Wände neu und laden zum Anfassen
und Erforschen ein. Entdecken
Sie eine Reihe kühner und subtiler
Entwürfe, von denen jeder ein Zeugnis
für die Kunst der Innenraumgestal-
tung ist.

ES —
Experimenta lo extraordinario con
nuestros revestimientos de pared 3D.
Paisajes esculturales y cautivadores.
Estas obras maestras redefinen
tus paredes, invitando al tacto y la
exploración. Descubre una variedad
de diseños audaces y sutiles, cada uno
siendo un testimonio del arte de la
transformación interior.

Where art meets science

Duropolymer isn't new to us, but our method is. We have been making profound changes in the full lifecycle of this product. We are merging bio-based raw materials with recycled elements to create this 100% biocircular masterpiece. And we've got the ISCC certification* to prove it (for the biobased share).



NL —
Duropolymer is niet nieuw voor ons, maar onze methode is dat wel. We hebben ingrijpende veranderingen aangebracht in de volledige levenscyclus van dit product. We combineren biobased grondstoffen met gerecyclede elementen (uit consumentenafval en industrieel afval) om dit 100% biocirculaire meesterwerk te creëren. En we hebben de ISCC-certificering* voor het biobased aandeel om het te bewijzen. Dit nieuwe tijdperk van milieubewuste decoratie is waar kunst wetenschap ontmoet.

FR —
Le duropolymer n'est pas une nouveauté pour nous, mais notre nouvelle méthode l'est. Nous avons fait des changements profonds dans le cycle de vie complet de ce produit. Nous fusionnons des matières premières biosourcées avec des éléments recyclés (issus de déchets post-consommation et post-industriels) pour créer ce chef-d'œuvre 100% biocirculaire. Et nous avons la certification ISCC* pour le prouver. Cette nouvelle ère de décoration éco-responsable est là où l'art rencontre la science.

DE —
Duropolymer ist für uns nicht neu, aber unsere neue Methode ist es. Wir haben den gesamten Lebenszyklus dieses Produkts grundlegend verändert. Wir verbinden biobasierte Rohstoffe mit recycelten Elementen (aus post-Consumer-Abfällen und post-industriellen Abfällen), um dieses 100% biozirkuläre Meisterwerk zu schaffen. Um dies zu belegen, haben wir die ISCC-Zertifizierung* für den biobasierten Anteil. In dieser neuen Ära des umweltbewussten Dekors trifft Kunst auf Wissenschaft.

ES —
El duropolymer no es nuevo para nosotros, pero sí lo es nuestro nuevo método. Hemos estado haciendo cambios significativos en el ciclo de vida completo de este producto. Estamos fusionando materiales de origen biológico con elementos reciclados (de desechos post-consumo y post-industriales) para crear esta obra maestra 100% biocircular. Y tenemos la certificación ISCC* para la parte de origen biológica para demostrarlo. Esta nueva era de diseño ecológico es donde el arte se encuentra con la ciencia.

Products

WX204 | WX204-2600 RIPPLE
Duropolymer®
200 x 25 x 1,6 cm
260 x 25 x 1,6 cm

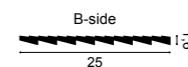
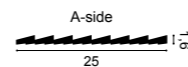

1 WX210 | WX210-2600 | WX210F REED **NEW**
Duropolymer®
200 x 25,5 x 1,2 cm
260 x 25,5 x 1,2 cm

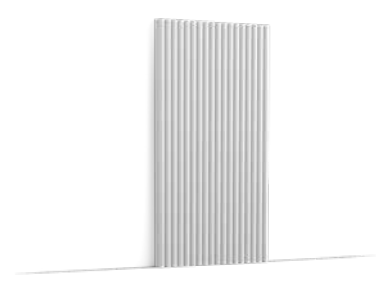

WX205 | WX205-2600 | WX205F TRACK
Duropolymer®
200 x 25 x 1,3 cm
260 x 25 x 1,3 cm

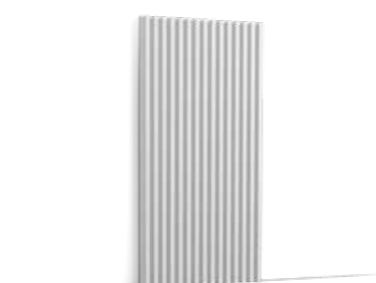
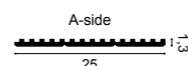

2 WX211 | WX211-2600 | WX211F FLUTE **NEW**
Duropolymer®
200 x 25,5 x 1,7 cm
260 x 25,5 x 1,7 cm



1. WX210 2. WX211

SX207 | SX207F SQUARE
Duropolymer®
200 x 25 x 1,3 cm

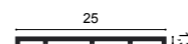

3D Wall covering



W108 | W108F ZIGZAG

Purotouch®
200 x 25 x 1,8 cm
Designed by Orio Tonini



W108 ZIGZAG + 2x CX190



⑤ W110 | W110F HILL

Purotouch®
200 x 25 x 1,6 cm
Designed by Orio Tonini

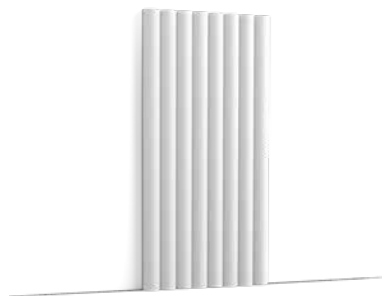
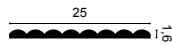

W110 HILL + 2x CX190



② W213 HILL TRACE (NEW)

Purotouch®
200 x 25 x 1,6 cm
Designed by Orio Tonini

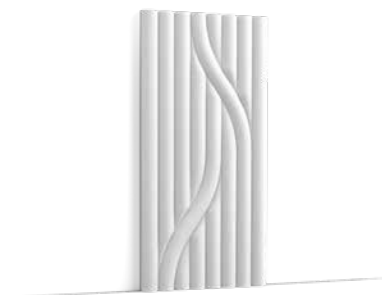
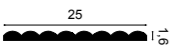

W214 | W214 HILL BEAD XL (NEW)

Purotouch®
200 x 40 x 1,5 cm
Designed by Orio Tonini



W215 HILL BEAD (NEW)

Purotouch®
50 x 80 x 1,5 cm
Designed by Orio Tonini



3D Wall coverings

1. PX209 p.131 2. W213 3. WX210 p.95 4. WX211 p.95 5. W110



1. W109 2. PX209 p.131 3. W212

⑥ W217 PILLOW **NEW**
Purotouch®
200 x 25 x 2,3 cm
Designed by Orio Tonini

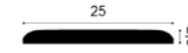

④ ⑥ W217 PILLOW + SX182 **NEW**



2. PX209 p.131 4. W217 5. W218 6. SX182 p.111



3D Wall Coverings

① W109 | W109F VALLEY
Purotouch®
200 x 25 x 1,2 cm
Designed by Orio Tonini

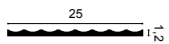

W114 | W114F VALLEY XL
Purotouch®
200 x 25 x 1,5 cm
Designed by Orio Tonini

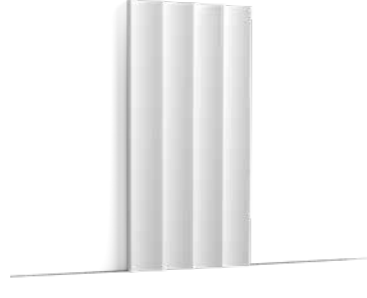
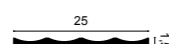

W109 VALLEY + 2x CX190

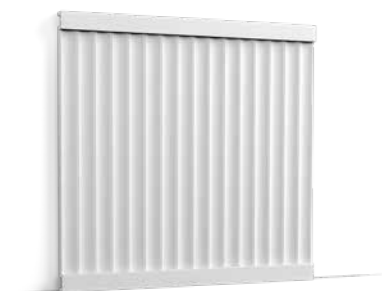

W114 VALLEY XL + 2x SX194



③ W212 VALLEY LOOP
Purotouch®
200 x 25 x 1,2 cm
Designed by Orio Tonini

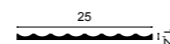

③ W212 VALLEY LOOP + 2x PX209



⑤ W218 QUILT **NEW**
Purotouch®
200 x 25 x 2,3 cm
Designed by Orio Tonini



⑤ ⑥ W218 QUILT + SX182 **NEW**



Beyond surface beauty

ACOUSTIC CONTRIBUTION — CLASS E

In combination with other elements, Purotouch has a positive effect on the overall sound quality, absorbing up to 25% of conversational sounds.

THERMAL COMFORT

Purotouch offers thermal insulation akin to specialty insulation boards of the same thickness.

$\lambda = 0,029 \text{ W/mK}$

ECO-CONSCIOUS FROM MATERIAL TO FINISH

Over 11% of Purotouch's composition is biobased, derived from sugar beet & cane. We extend this approach up until the 14% biobased primer paint we use.

NL –

AKOESTISCHE BIJDRAGE - KLASSE E

Purotouch heeft, in combinatie met andere elementen in de ruimte, een positief akoestisch effect, en absorbeert tot 25% van een gesprek.

THERMISCH COMFORT

Purotouch biedt een gelijkwaardige thermische isolatie als isolatieplaten van dezelfde dikte. $\lambda = 0,029 \text{ W/mK}$

MILIEUBEWUST VAN MATERIAAL TOT AFWERKING

Meer dan 11% van de samenstelling van Purotouch is biobased, afgeleid van suikerbiet en suikerriet. We trekken deze aanpak door tot en met de 14% biobased primerverf die we gebruiken.

FR –

CONTRIBUTION ACOUSTIQUE - CLASSE E

En combinaison avec d'autres éléments, Purotouch a un effet positif sur la qualité sonore globale en absorbant jusqu'à 25 % des bruits de conversation.

CONFORT THERMIQUE

Purotouch offre une isolation thermique comparable à celle des panneaux d'isolation de la même épaisseur. $\lambda = 0,029 \text{ W/mK}$

ÉCO-CONSCIENT DU MATÉRIAU À LA FINITION

Plus de 11% de la composition de Purotouch® est biosourcée, dérivée de la betterave et de la canne à sucre. Nous poursuivons cette approche jusqu'à la peinture d'apprêt biosourcée (14 %) que nous utilisons.

DE –

AKUSTISCHER BEITRAG - KLASSE E

In Kombination mit anderen Elementen hat Purotouch einen positiven Effekt auf die Gesamtklangqualität und absorbiert bis zu 25% des Raumschalls.

THERMISCHER KOMFORT

Purotouch bietet eine Wärmedämmung vergleichbar mit der einer Dämmplatte derselben Stärke. $\lambda = 0,029 \text{ W/mK}$

UMWELTBEWUSST VOM MATERIAL BIS ZUR VERARBEITUNG

Mehr als 11% der Zusammensetzung von Purotouch ist biobasiert und stammt aus Zuckerrüben und Zuckerrohr. Wir erweitern diesen Ansatz bis hin zu die 14% biobasierte Grundierfarbe, die wir verwenden.

ES –

CONTRIBUCIÓN ACÚSTICA - CLASE E

En combinación con otros elementos, nuestros productos Purotouch tienen un efecto positivo en la calidad general del sonido, absorbiendo hasta un 25% de los sonidos de conversación.

CONFORT TÉRMICO

Purotouch ofrece un aislamiento térmico similar al material aislante del mismo espesor. $\lambda = 0,029 \text{ W/mK}$

CONCIENCIA ECOLÓGICA DESDE EL MATERIAL HASTA EL ACABADO

Más del 11% de la composición de Purotouch es de origen biológico, derivado de la remolacha y la caña de azúcar. Ampliamos este enfoque hasta la pintura de imprimación biobasada (14%).



1. W116 2. W111 3. W119 4. CX190 p.116

3D Wall covering

② W111 | W111F BAR
Purotouch®
200 x 25 x 2 cm
Designed by Orio Tonini

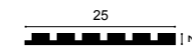

① W116 | W116F BAR XL
Purotouch®
200 x 25 x 2 cm
Designed by Orio Tonini

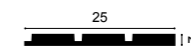

③ W119 | W119F BAR MIX
Purotouch®
200 x 25 x 2 cm
Designed by Orio Tonini



② ④ W111 BAR + CX190 + PX198



① ④ W116 BAR XL + CX190 + PX198



③ ④ W119 BAR MIX + CX190 + PX198



② **W115 SLOPE**
 Purotouch®
 200 x 25 x 2,3

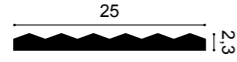

⑤ **W216 MATRIX** **NEW**
 Purotouch®
 200 x 25 x 1,6 cm
 Designed by Orio Tonini

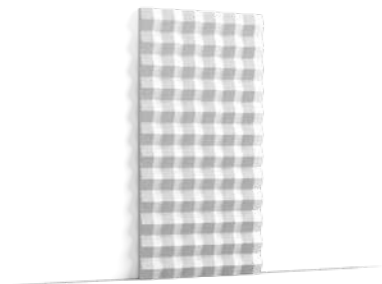
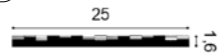

1. CX196 p.142 2. W115 3. CX190 p.116 4. PX198 p.116



5. W216

3D Wall covering

W112 RIDGE
 Purotouch®
 200 x 25 x 1,9 cm
 Designed by Orio Tonini

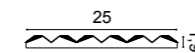

W113 COBBLE
 Purotouch®
 200 x 25 x 2,2 cm
 Designed by Orio Tonini

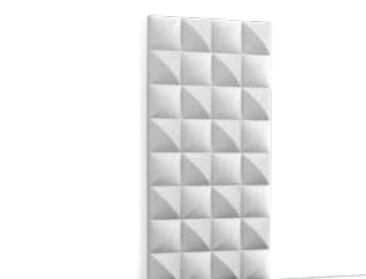
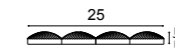

W130 CHEVRON
 Purotouch®
 200 x 40 x 2 cm

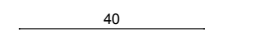

W112 RIDGE + 2x CX190



W113 COBBLE + 2x CX190

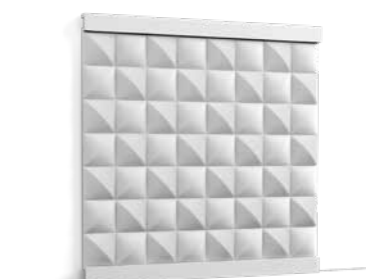

W130 CHEVRON + 2x CX190

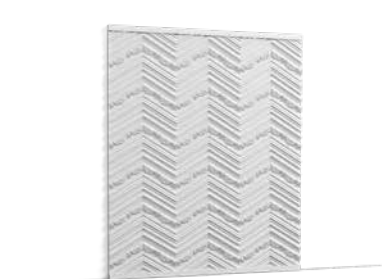

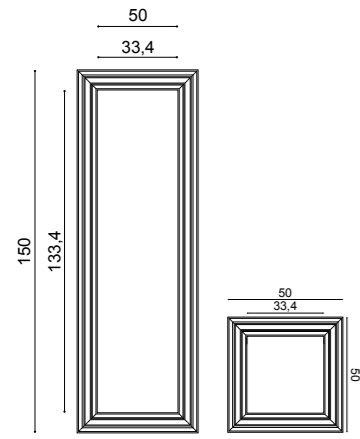

W120 + P4025 + W121
Purotouch®
Designed by Orio Tonini

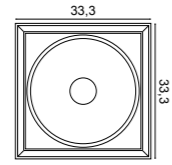
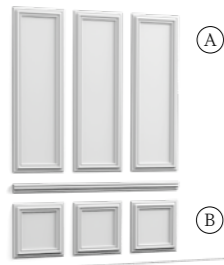

W122 AUTOIRE
Purotouch®
33,3 x 33,3 x 2,6 cm
Designed by Orio Tonini

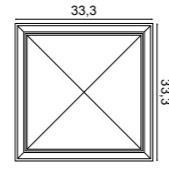

W123 AUTOIRE
Purotouch®
33,3 x 33,3 x 3,5 cm
Designed by Orio Tonini



1. DX170-2300 p.154 2. D330LR p.154 3. W120 4. W121 5. SX138 p.113



3D Wall covering

③ **W120 AUTOIRE**
Purotouch®
50 x 150 x 3,2 cm
Designed by Orio Tonini



W120 + 4*W122
Purotouch®
Designed by Orio Tonini



W120 + 4*W123
Purotouch®
Designed by Orio Tonini



④ **W121 AUTOIRE**
Purotouch®
50 x 50 x 3,2 cm
Designed by Orio Tonini



W121 + W122
Purotouch®
Designed by Orio Tonini

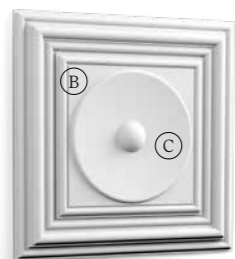

W121 + W123
Purotouch®
Designed by Orio Tonini

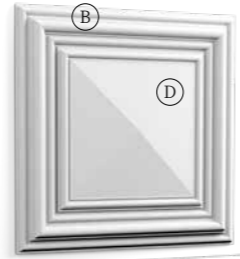

W100 ROMBUS
Purotouch®
25,8 x 15 x 2,9 cm

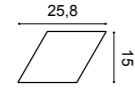

W101 TRAPEZIUM
Purotouch®
34,5 x 15 x 2,9 cm

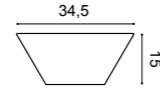

W105 ROMBUS
Purotouch®
30 x 34,6 x 3 cm

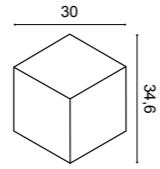

1. W106 2. W107



① **W106 ENVELOP**
Purotouch®
33,3 x 33,3 x 2,9 cm
Designed by Orio Tonini

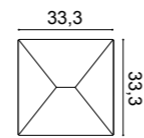

② **W107 CIRCLE**
Purotouch®
33,3 x 33,3 x 2,9 cm
Designed by Orio Tonini

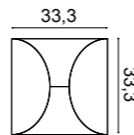

1. F30



PLAFONDDECORATIE
DÉCORATION DE PLAFONDS
DECKENZIERELELEMENTE
DECORACIONES PARA TECHO

Ceiling ornaments

3D Wall covering

F30
Purotouch®
59,5 x 59,5 x 4,3 cm

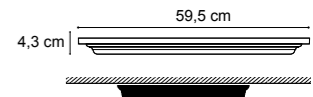

Skirting boards

ORAC

Products

03

PLINTEN
PLINTHES
SOCKELLEISTEN
ZÓCALOS

Crafting seamless transitions from floor to wall, from the elegantly ornate to the gracefully understated. We pay meticulous attention to every detail in every design so you can find options that match your vision.

NL —
Een naadloze overgang van vloer tot muur. Van elegant sierlijk tot sierlijk ingetogen. Elk detail goed doordacht uitgewerkt om altijd een optie te vinden die bij je past.

FR —
La création de transitions harmonieuses entre le sol et la surface, de l'élégamment orné au gracieusement discret. Nous accordons une attention méticuleuse aux détails dans chaque conception, afin que vous puissiez trouver les options qui correspondent à votre vision.

DE —
Wir schaffen nahtlose Übergänge vom Boden zur Wand. Von elegant verziert bis hin zu anmutig schlicht. Wir legen bei jedem Entwurf besonderen Wert auf die Details, damit Sie die Möglichkeiten finden, die Ihre Visionen wahr werden lassen.

ES —
Transiciones perfectas del suelo a la pared, delo suntuosamente ornamentado hasta lo sutilmente sofisticado. Prestamos una meticulosa atención a los detalles en cada diseño, para que encuentres opciones que se ajusten a tu visión.

Three cornerstone skirting families

They invite you to create.

NL —
Drie basis plintfamilies
Ze nodigen je uit om te creëren

FR —
Trois familles de plinthes clés
Une invitation à la créativité

DE —
Drei Sockel-Designfamilien
als Eckpfeiler
Sie laden Sie ein, etwas zu erschaffen

ES —
Tres familias de zócalos
fundamentales
Te invitan a crear



1. SX118 2. PX103 p.129

Products

**SX162 | SX162F |
SX162-RAL9003 SQUARE**
Duropolymer®
200 x 4 x 1 cm



**SX182 | SX182F |
SX182-RAL9003 CASCADE**
Duropolymer®
200 x 5 x 1,3 cm



**SX165 | SX165F |
SX165-RAL9003 CONTOUR**
Duropolymer®
200 x 6,9 x 1,1 cm



**SX157 | SX157F |
SX157-RAL9003 SQUARE**
Duropolymer®
200 x 6,6 x 1,3 cm



**SX183 | SX183F |
SX183-RAL9003 CASCADE**
Duropolymer®
200 x 7,5 x 1,3 cm



**SX173 | SX173F |
SX173-RAL9003 CONTOUR**
Duropolymer®
200 x 10 x 1,6 cm



**SX163 | SX163F |
SX163-RAL9003 SQUARE**
Duropolymer®
200 x 10,1 x 1,3 cm



**SX184 | SX184F |
SX184-RAL9003 CASCADE**
Duropolymer®
200 x 11 x 1,3 cm



**SX118 | SX118F |
SX118-RAL9003 CONTOUR**
Duropolymer®
200 x 13,9 x 1,8 cm



SX171 | SX171-RAL9003 SQUARE
Duropolymer®
200 x 10 x 2,2 cm



SX185 CASCADE
Duropolymer®
200 x 12 x 2,5 cm



SX186 CONTOUR
Duropolymer®
200 x 13,8 x 2,2 cm



Square

Cascade

Contour

small

medium

large

cover

Skirting boards

SX195 | SX195F HAMBURG
Duropolymer®
200 x 8 x 1,9 cm



SX105 | SX105F
Duropolymer®
200 x 11 x 1,3 cm

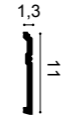

SX155 | SX155F
Duropolymer®
200 x 10,8 x 2,5 cm

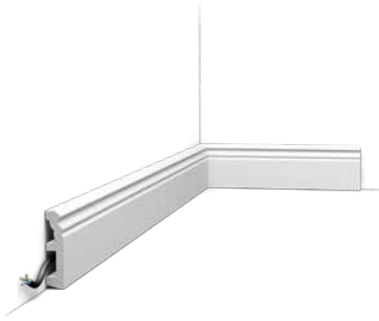

1. DX170-2300 p.154 2. P9010 p.124 3. P9050 p.126 4. SX155



1. W120 p.104 2. W121 p.104 3. W122 p.104 4. W123 p.104 5. P4025 p.124 6. SX138 p.113

SX137 | SX137F
Duropolymer®
200 x 10 x 1,5 cm

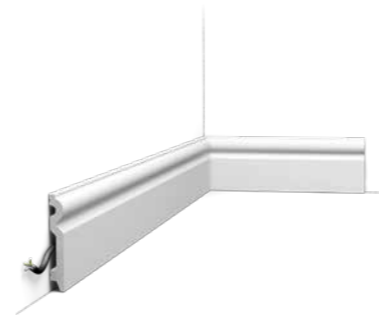

SX138 | SX138F
Duropolymer®
200 x 13,8 x 1,5 cm



SX206 CONTOUR
Duropolymer®
200 x 18 x 1,8 cm



SX193 AUTOIRE
Duropolymer®
200 x 25 x 2,2 cm
Designed by Orio Tonini

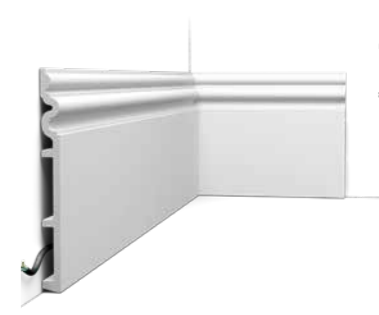

SX187 | SX187F HIGH LINE
Duropolymer®
200 x 7,5 x 1,2 cm
Designed by Pierre Daems



SX180 | SX180F HIGH LINE
Duropolymer®
200 x 12 x 1,6 cm
Designed by Pierre Daems

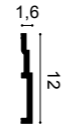

SX181 HIGH LINE
Duropolymer®
200 x 20 x 2,2 cm
Designed by Pierre Daems



1- P7070 p.126 2- SX180



Skirting boards

3- W120 p.104 4- W121 p.104 5- SX191

SX104 | SX104F
Duropolymer®
200 x 15 x 1,8 cm



SX156 HIGH HEELS
Duropolymer®
200 x 20,2 x 1,6 cm
Designed by Xavier Donck



SX191 HIGH RISE
Duropolymer®
200 x 21 x 2,1 cm

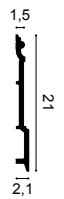

SX194 | SX194F SQUARE
Duropolymer®
200 x 2 x 1 cm

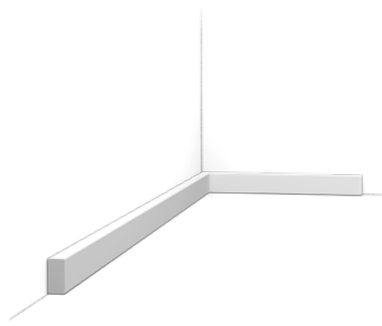

CX132 | CX132F
Duropolymer®
200 x 2 x 2 cm



CX133
Duropolymer®
200 x 2 x 2 cm



¹ C343 p.66 ² P8020 p.124 ³ CX190 ⁴ W109 p.98

³ **SX190 | CX190F U-PROFILE**
Duropolymer®
200 x 3 x 2 cm
Designed by Orio Tonini



PX198 | PX198F U-STEPS
Duropolymer®
200 x 8,3 x 2 cm
Designed by Orio Tonini

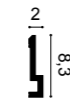

PX198 | PX198F U-STEPS 180°
Duropolymer®
200 x 8,3 x 2 cm
Designed by Orio Tonini



SX159
Duropolymer®
200 x 6 x 1,2 cm

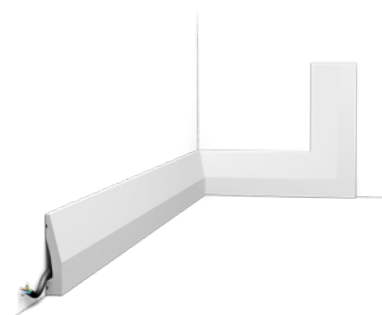

SX125
Duropolymer®
200 x 6,9 x 1,4 cm

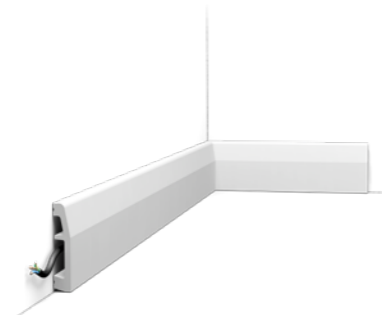

SX179 DIAGONAL
Duropolymer®
200 x 9,7 x 2,9 cm
Designed by Orio Tonini

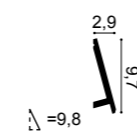

SX172 | SX172F
Duropolymer®
200 x 8,5 x 1,4 cm



SX212 CASCADE NEW
Duropolymer®
200 x 17 x 1,3 cm



Skirting boards

Multifunctional

MULTIFUNCTIONEEL
MULTIFONCTIONNEL
MULTIFUNKTIONAL
MULTIFUNCIONAL

ORAC

Products

PX198 | PX198F U-STEPS
Duropolymer®
200 x 8,3 x 2 cm
Designed by Orio Tonini



PX198 | PX198F U-STEPS 180°
Duropolymer®
200 x 8,3 x 2 cm
Designed by Orio Tonini



SX182 | SX182F CASCADE
Duropolymer®
200 x 5 x 1,3 cm

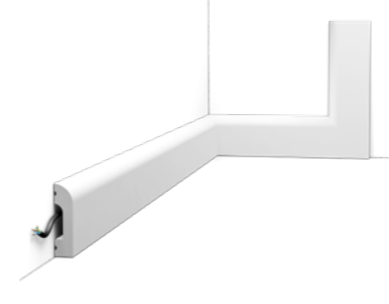

SX183 | SX183F CASCADE
Duropolymer®
200 x 7,5 x 1,3 cm



SX184 | SX184F CASCADE
Duropolymer®
200 x 11 x 1,3 cm



CX190 | CX190F U-PROFILE
Duropolymer®
200 x 3 x 2 cm
Designed by Orio Tonini

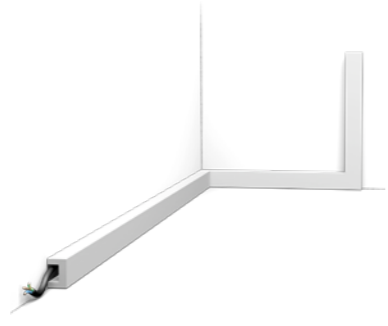

SX159
Duropolymer®
200 x 6 x 1,2 cm

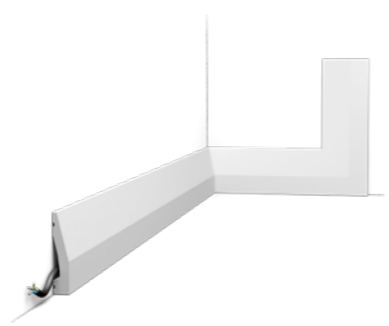

SX187 | SX187F HIGH LINE
Duropolymer®
200 x 7,5 x 1,2 cm
Designed by Pierre Daems



SX180 | SX180F HIGH LINE
Duropolymer®
200 x 12 x 1,6 cm
Designed by Pierre Daems

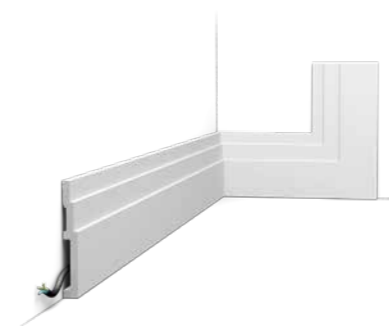

SX181 HIGH LINE
Duropolymer®
200 x 20 x 2,2 cm
Designed by Pierre Daems



SX194 | SX194F SQUARE
Duropolymer®
200 x 2 x 1 cm

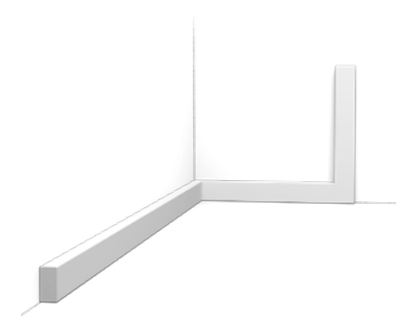

SX162 | SX162F SQUARE
Duropolymer®
200 x 4 x 1 cm

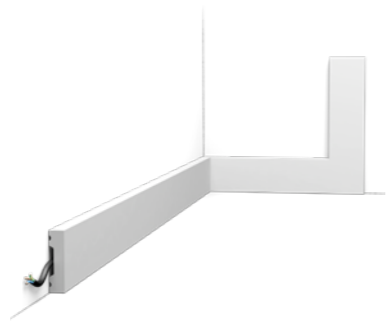

SX157 | SX157F SQUARE
Duropolymer®
200 x 6,6 x 1,3 cm

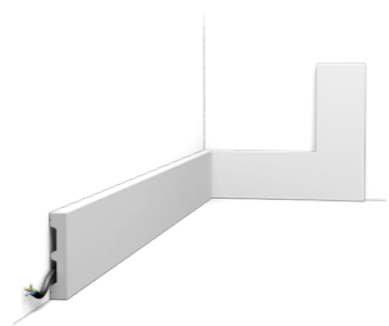

SX163 | SX163F SQUARE
Duropolymer®
200 x 10,1 x 1,3 cm



SX168 SQUARE
Duropolymer®
200 x 15 x 1,3 cm



SX207 | SX207F SQUARE
Duropolymer®
200 x 25 x 1,3 cm



¹ P7070 p.126 ² SX180

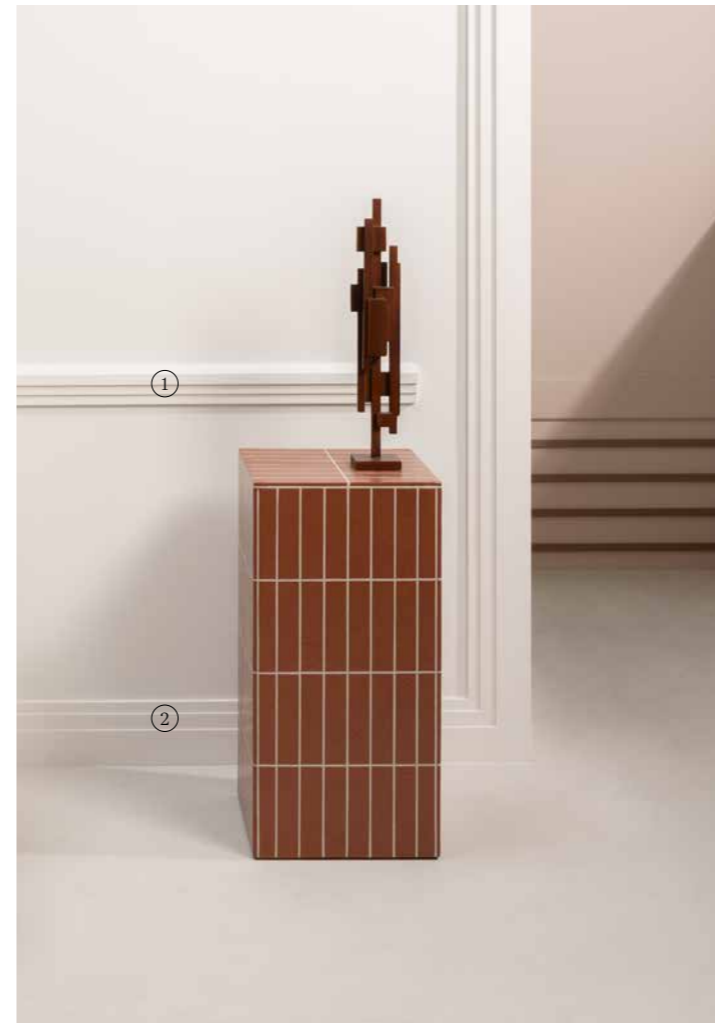

We embrace limitless possibilities. Our profiles flow seamlessly from a moulding to a door frame, fostering creativity.

NL — Grenzeloze mogelijkheden. Onze profielen transformeren en stimuleren creativiteit. Van een lijst tot een deurkozijn.

FR — Nous vous offrons des possibilités illimitées. Nos profils se transforment, passant d'une moulure à un cadre de porte, favorisant ainsi la créativité.

DE — Wir fördern grenzenlose Möglichkeiten. Unsere Profile verwandeln sich nahtlos von einer Sockelleiste in eine Türumrandung und wecken so Kreativität.

ES — Creemos en las posibilidades ilimitadas. Nuestros perfiles se transforman, desde una moldura hasta el marco de una puerta, fomentando la creatividad.

1. CX190 p.118



Paintable
Overschilderbaar
Peut être peinte
Überstreichbar
Listo para pintar

Water resistant
Waterbestendig
Résistante à l'eau
Wasserfest
Resistente al agua

Ideal for renovations
Ideaal voor renovatie
Idéale pour les rénovations
Ideal für die Renovierung
Ideal para reformas

2. PX175 p.129 3. SX185

SX171 | SX171-RAL9003 SQUARE
Duropolymer®
200 x 10 x 2,2 cm

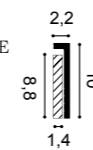

3. **SX185 CASCADE**
Duropolymer®
200 x 12 x 2,5 cm

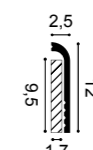

SX186 CONTOUR
Duropolymer®
200 x 13,8 x 2,2 cm



Panel mouldings

04

ORAC

Products

WANDLIJSTEN
CIMAISES
WAND - UND FRIESLEISTEN
MOLDURAS

An empty wall is like a bare base, in need of shape and dimension. Which is why we love to entertain ideas with these versatile accents. By using our panel mouldings, harmony comes into play, a sense of proportion that is balanced and pleasing to the eye.

NL—
Een lege muur is als een onbeschreven blad, klaar om vorm en dimensie te krijgen. Daarom spelen we graag met ideeën die deze veelzijdige accenten benutten. Met onze paneelprofielen brengen we harmonie aan, een gevoel van evenwicht en verhouding dat het oog streelt.

FR—
Un mur vide ressemble à une page blanche en attente de prendre forme. C'est pourquoi nous aimons infuser de nouvelles idées avec ces accents polyvalents. L'utilisation de nos cimaises permet de créer une harmonie, un équilibre visuellement agréable et bien proportionné.

DE—
Eine leere Wand gleicht einer blanken Grundlage, die Form und Dimension bedarf. Deshalb lieben wir es, Ideen mit vielseitigen Akzenten zu entwickeln. Durch die Verwendung unserer Wandleisten kommt Harmonie ins Spiel - ein Gefühl von Proportion, das ausgewogen und angenehm für das Auge ist.

ES—
Una pared vacía es como un lienzo en blanco: necesita forma y dimensión. Por eso nos encanta dar vida a tus ideas con estas referencias tan versátiles. Al utilizar molduras entra en juego la armonía y una sensación de proporción equilibrada y agradable a la vista.

P8030 | P8030F
Purotouch®
200 x 4,1 x 1,7 cm

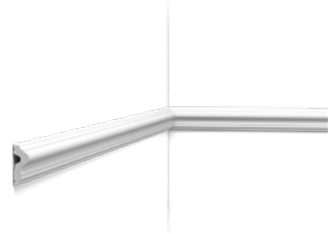

② P8020 | P8020F
Purotouch®
200 x 6 x 2,6 cm

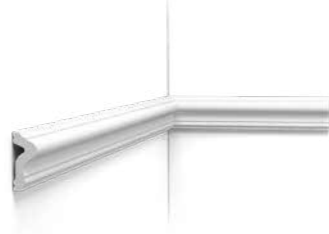

③ P8050 | P8050F
Purotouch®
200 x 12 x 3 cm



P1020
Purotouch®
200 x 4,9 x 2,4 cm

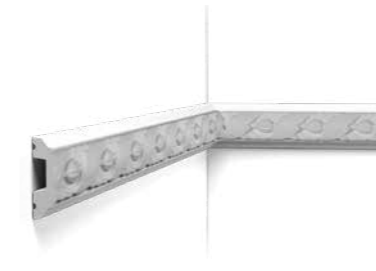

P3020 | P3020F
Purotouch®
200 x 6,1 x 3,2 cm



P4020 | P4020F
Purotouch®
200 x 5 x 2,9 cm

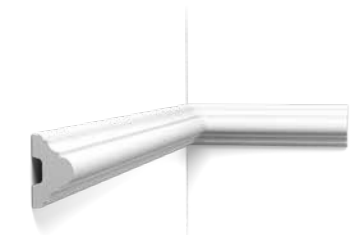

P9040
Purotouch®
200 x 5 x 2,5 cm



P9010 | P9010F
Purotouch®
200 x 9,1 x 3 cm

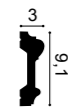

P8040 | P8040F
Purotouch®
200 x 10,1 x 2,2 cm

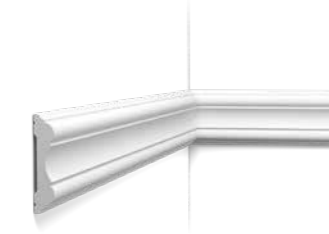

P4025 | P4025F AUTOIRE
Purotouch®
200 x 8,3 x 3,4 cm
Designed by Orio Tonini

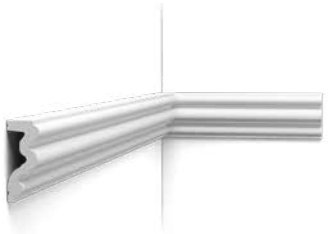

P9020
Purotouch®
200 x 9,6 x 2,1 cm

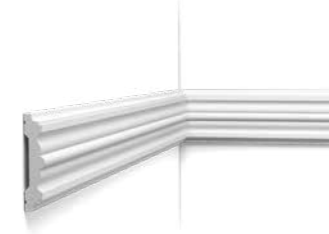

1. P8050 2. P8020 3. P8030



P6020
Purotouch®
200 x 6,4 x 2,8 cm

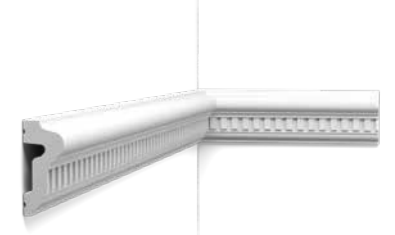

P7030
Purotouch®
200 x 8,5 x 1,7 cm

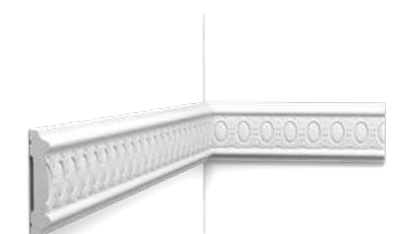

P7020
Purotouch®
200 x 11,1 x 1,9 cm



Panel moldings

② **P9050 | P9050F**
Purotouch®
200 x 2,5 x 1,3 cm



P5021 | P5021F
Purotouch®
200 x 3,1 x 0,9 cm

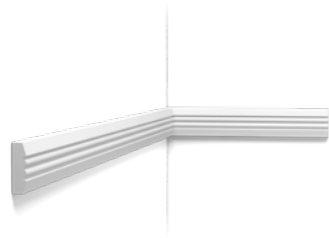

P7070 | P7070F
Purotouch®
200 x 7,4 x 2,2 cm

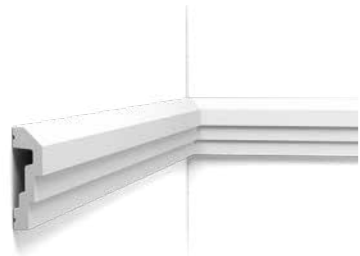

P9900 | P9900F
Purotouch®
200 x 8 x 1 cm

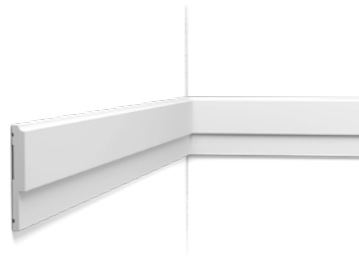
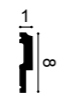

P8060
Purotouch®
200 x 5 x 3,5 cm

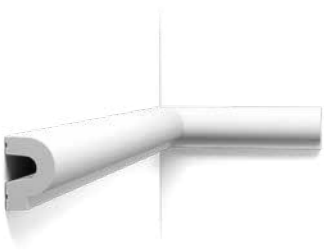

P9901
Purotouch®
200 x 7 x 1,4 cm

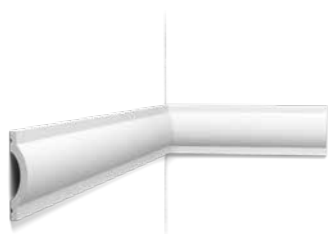

P3070 RADIUS
Purotouch®
200 x 12,5 x 3,2 cm
Designed by Ulf Moritz

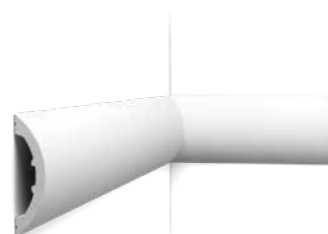
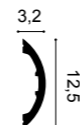

P3071 GOLF
Purotouch®
200 x 37,2 x 7,6 cm
Designed by Ulf Moritz

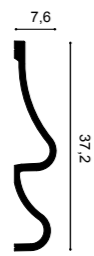

1. P9010 p.124 2. P9050 3. SX155 p.112

DX174-2300 | DX174F
 Duropolymer®
 230 x 6 x 2,2 cm (DX174-2300)
 200 x 6 x 2,2 cm (DX174F)



DX170-2300
 Duropolymer®
 230 x 11,9 x 3,2 cm

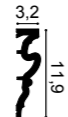

DX119-2300
 Duropolymer®
 230 x 9,2 x 2,2 cm



DX121-2300
 Duropolymer®
 230 x 9,4 x 2,3 cm

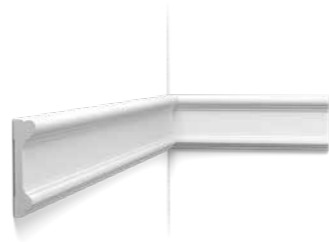
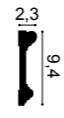

PX103 | PX103F
 Duropolymer®
 200 x 2,5 x 1,2 cm

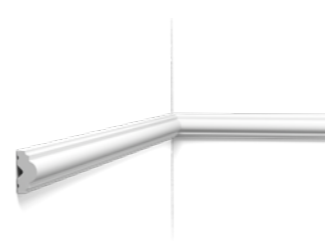

PX120 | PX120F
 Duropolymer®
 200 x 4 x 1,9 cm

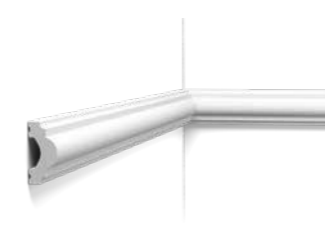
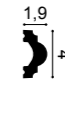

PX201 | PX201F
 Duropolymer®
 200 x 2,5 x 0,9 cm

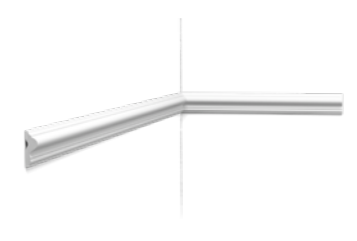
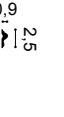

PX175 | PX175F
 Duropolymer®
 200 x 5 x 1,7 cm

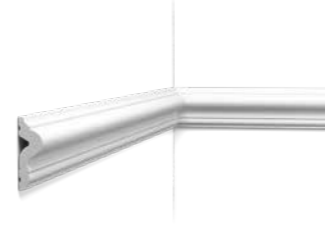

PX202 | PX202F
 Duropolymer®
 200 x 7,5 x 2 cm

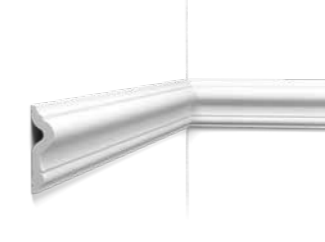

PX116
 Duropolymer®
 200 x 3,1 x 1 cm

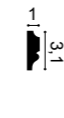

PX117
 Duropolymer®
 200 x 3,5 x 1,5 cm

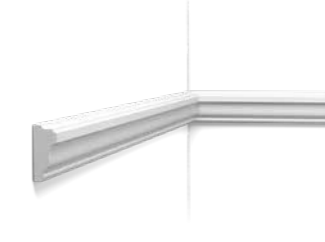

PX113
 Duropolymer®
 200 x 6 x 2,7 cm

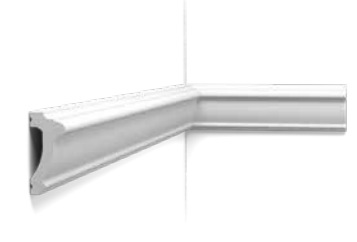

PX144 | PX144F
 Duropolymer®
 200 x 4,7 x 0,8 cm

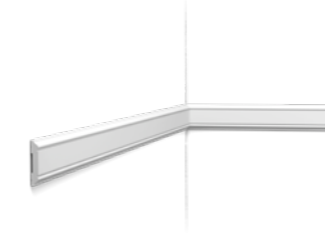
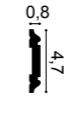

SX159
 Duropolymer®
 200 x 6 x 1,2 cm



¹ P8020 p.124 ² P4020 p.124 ³ SX206 p.113





1. PX209 2. SX207

SX194 | SX194F SQUARE
Duropolymer®
200 x 2 x 1 cm

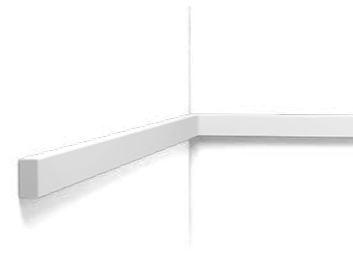

SX162 | SX162F SQUARE
Duropolymer®
200 x 4 x 1 cm

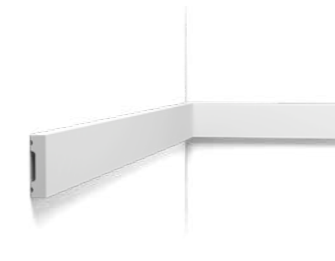

SX157 | SX157F SQUARE
Duropolymer®
200 x 6,6 x 1,3 cm

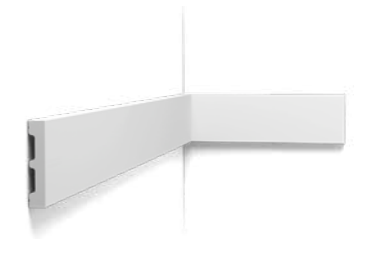

SX163 | SX163F SQUARE
Duropolymer®
200 x 10,1 x 1,3 cm

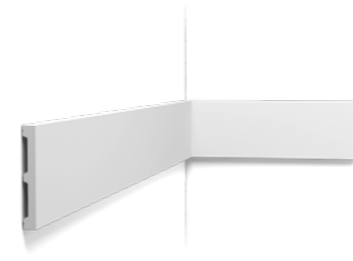

SX168 SQUARE
Duropolymer®
200 x 15 x 1,3 cm

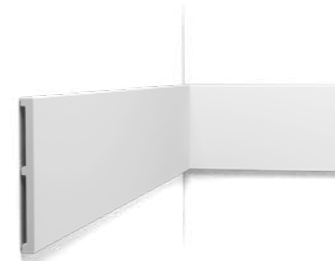
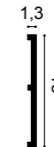

② **SX207 | SX207F SQUARE**
Duropolymer®
200 x 25 x 1,3 cm



PX169 (A)
Duropolymer®
200 x 5,5 x 3,4 cm

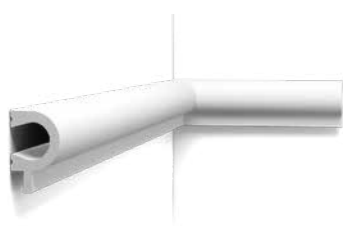

PX147 (B)
Duropolymer®
200 x 16,9 x 0,9 cm



PX169 + PX147



SX182 | SX182F CASCADE
Duropolymer®
200 x 5 x 1,3 cm



SX183 | SX183F CASCADE
Duropolymer®
200 x 7,5 x 1,3 cm

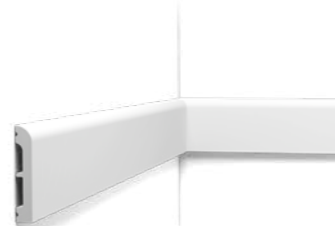

SX184 | SX184F CASCADE
Duropolymer®
200 x 11 x 1,3 cm

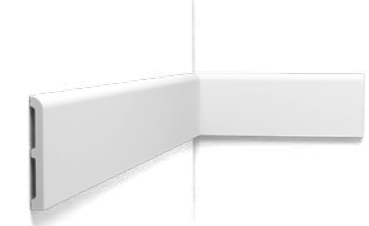

CX190 | CX190F U-PROFILE
Duropolymer®
200 x 3 x 2 cm
Designed by Orio Tonini



PX198 | PX198F U-STEPS
Duropolymer®
200 x 8,3 x 2 cm
Designed by Orio Tonini

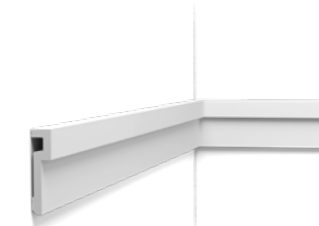

CX197 U-STEPS
Duropolymer®
200 x 9,3 x 5 cm
Designed by Orio Tonini



SX212 CASCADE (NEW)
Duropolymer®
200 x 17 x 1,3 cm



① **PX209 | PX209F RIBBON**
Duropolymer®
200 x 1 x 1,8 cm
Designed by Orio Tonini



CX134
Duropolymer®
200 x 3 x 3 cm



1- P3020 p.125 2- P3020A 3- P8050 p.124



P101A + P1020
Purotouch®
24,5 x 24,5 x 2,4 cm

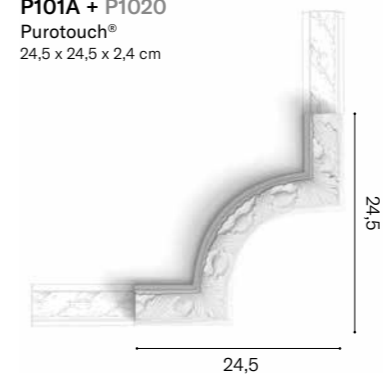

P801C + P8020
Purotouch®
19,8 x 11 x 2,6 cm



P4020A + P4020
Purotouch®
16,4 x 9,1 x 2,9 cm



2 P3020A + P3020
Purotouch®
42,5 x 42,5 x 4 cm

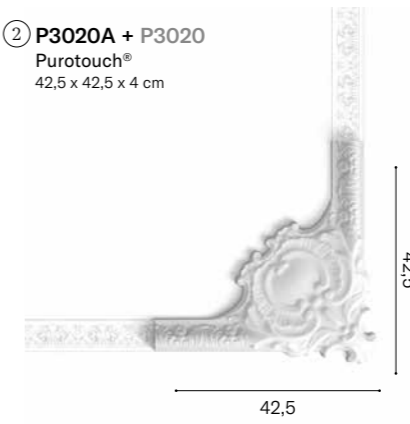

P20 + P101A
Duropolymer®
Ø 6,1 - 0,8 cm

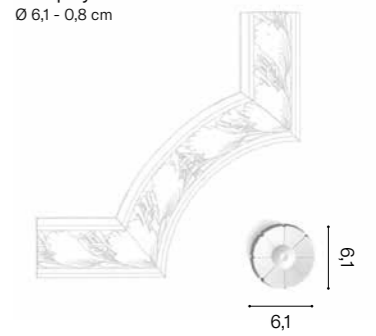

PX103A + PX103
Duropolymer®
19 x 3,5 x 1,5 cm

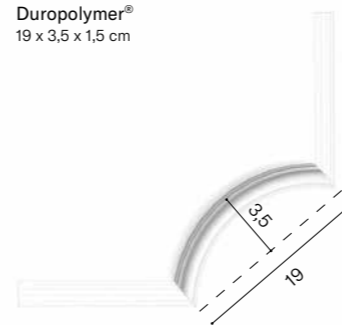

P8030D + P8030
Duropolymer®
13,2 x 13,2 x 1,7 cm

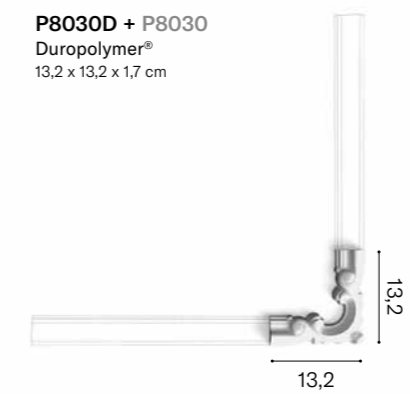

PX120A + PX120
Duropolymer®
19 x 8,8 x 2 cm

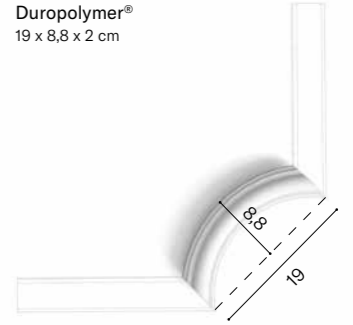

P8030C + P8030
Duropolymer®
19 x 8,6 x 1,7 cm

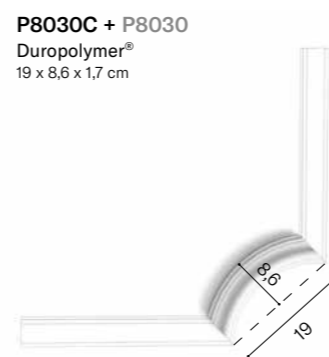

the perfect finish



PG.158-161

Indirect lighting

ORAC

05

Products

INDIRECTE VERLICHTING
ÉCLAIRAGE INDIRECT
INDIREKTE BELEUCHTUNG
ILUMINACIÓN INDIRECTA

Our indirect lighting solutions are the unseen maestros of ambiance. They are as versatile as they are subtle, designed to enhance every line and curve. So, we encourage you to integrate them as you see fit, for you to create an atmosphere that complements the time of day and the essence of the moment.

NL —
Onze indirecte verlichting zijn de onzichtbare dirigenten van sfeer. Ze zijn net zo veelzijdig als subtiel, ontworpen om elke lijn en ronding tot hun recht te laten komen. Creëer een omgeving die het moment van de dag en het 'nu' van het moment versterkt.

FR —
Nos solutions d'éclairage indirect sont les maîtres invisibles de l'ambiance. Aussi polyvalentes que subtiles, elles sont conçues pour mettre en valeur chaque ligne et chaque courbe. Nous vous encourageons donc à les intégrer comme bon vous semble, afin de créer une atmosphère qui s'accorde avec l'heure de la journée et l'essence du moment.

DE —
Unsere indirekten Beleuchtungslösungen sind die unsichtbaren Meister des Ambientes. Sie sind ebenso vielseitig wie subtil und betonen jede Linie und jede Kurve. Wir möchten Sie daher ermutigen, sie nach Ihrem Geschmack zu integrieren, um eine Atmosphäre zu schaffen, die der Essenz des Augenblicks gerecht wird.

ES —
Nuestras soluciones de iluminación indirecta son los artifices ocultos del ambiente. Son tan versátiles como sutiles, diseñados para realzar cada línea y curva. Por ello, animamos a integrarlos para crear una atmósfera que armonice con el momento del día y capture la esencia de cada instante.

② **C323**
Purotouch®
200 x 5,5 x 4,2 cm

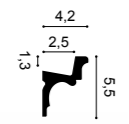

C324 AUTOIRE
Purotouch®
200 x 8,3 x 3,4 cm
Designed by Orio Torini

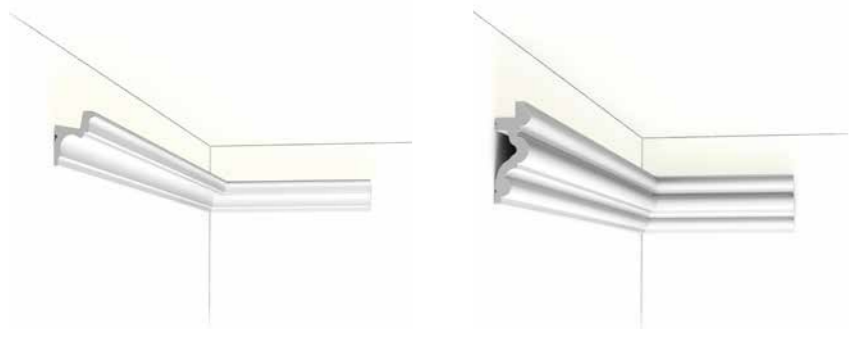
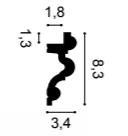

1. W212 p.98 2. C323 3. W109 p.98 4. PX209 p.131 5. SX118 p.111



C357 STRAIGHT
Purotouch®
200 x 7,1 x 11 cm
Designed by Jacques Vergracht

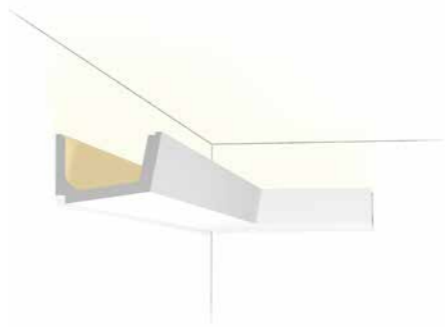
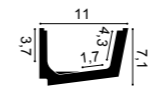

C352 FLAT
Purotouch®
200 x 7,6 x 17,1 cm
Designed by Jacques Vergracht

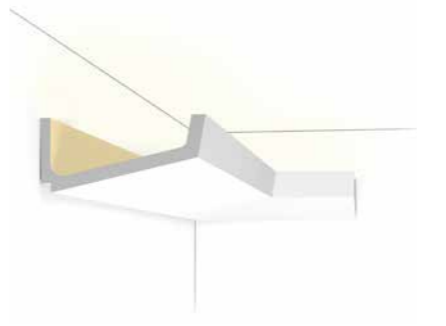
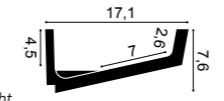

⑥ **C902 | C902F**
Purotouch®
200 x 10,3 x 10,3 cm
Designed by Jacques Vergracht

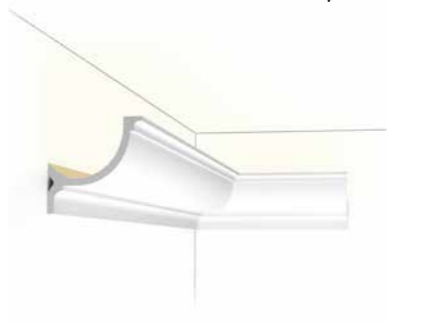
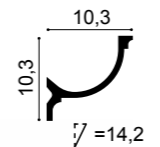

C901 | C901F
Purotouch®
200 x 14,8 x 12,4 cm
Designed by Jacques Vergracht

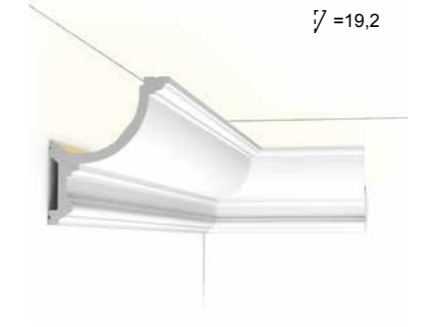
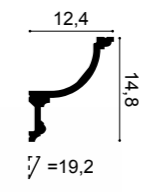

C900
Purotouch®
200 x 17,1 x 14,6 cm
Designed by Jacques Vergracht

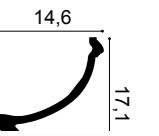

⑥ **C902**

Indirect lighting

L3 lighting combinations

ORAC

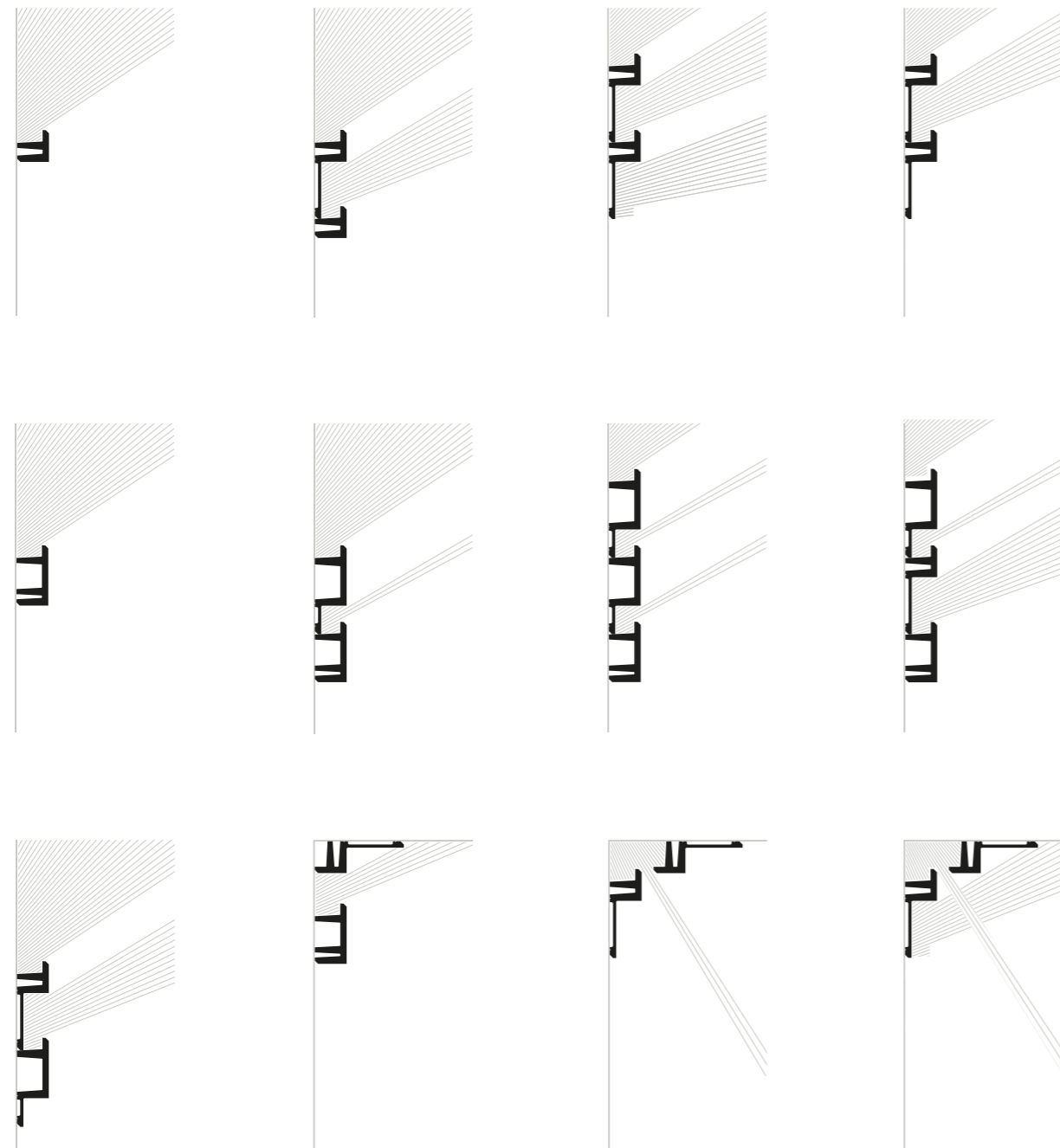

Products

③ **C380** L3 LINEAR LED LIGHTING
Purotouch®
200 x 5 x 5 cm
Designed by Orio Tonini

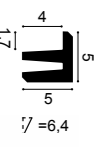

C381 L3 LINEAR LED LIGHTING
Purotouch®
200 x 9,5 x 5 cm
Designed by Orio Tonini

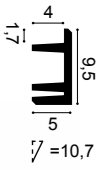

① **C382** L3 LINEAR LED LIGHTING
Purotouch®
200 x 14 x 5 cm
Designed by Orio Tonini

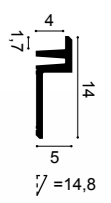

② **C383** L3 LINEAR LED LIGHTING
Purotouch®
200 x 14 x 5 cm
Designed by Orio Tonini

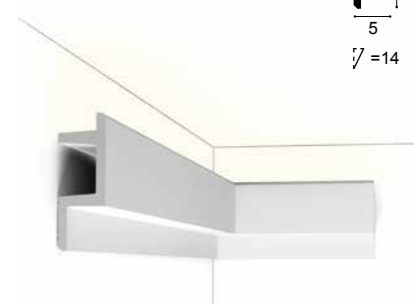
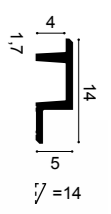

Indirect lighting

1. C382 2. C383 3. C380 4. SX180 p.114

1. C394 2. C393 p.79 3. SX180 p.114

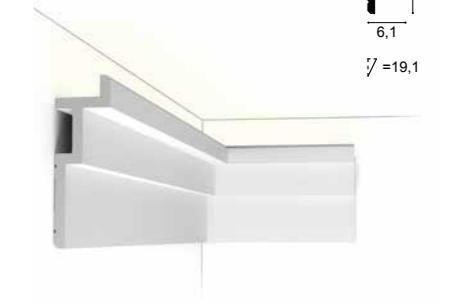
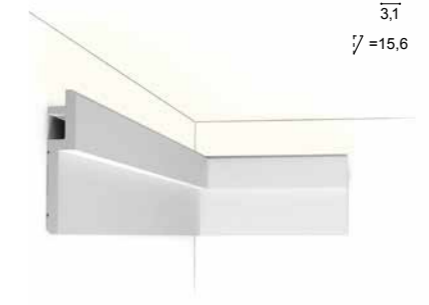
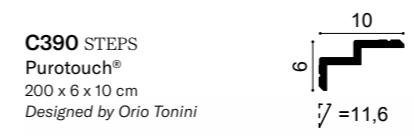
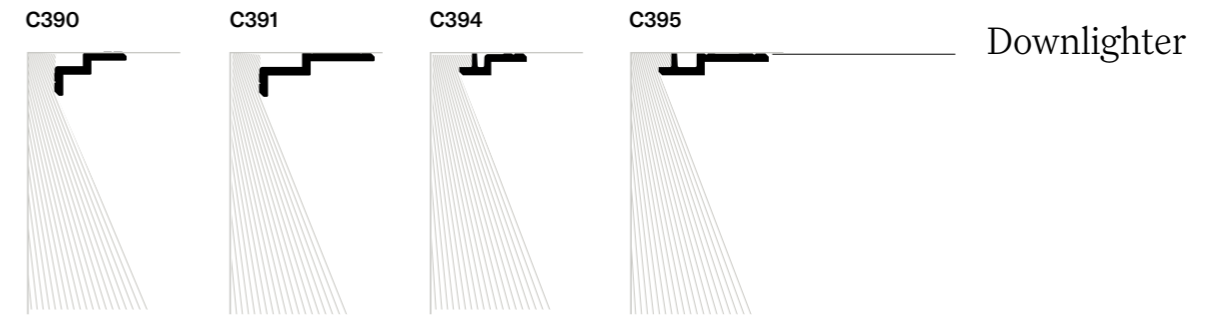
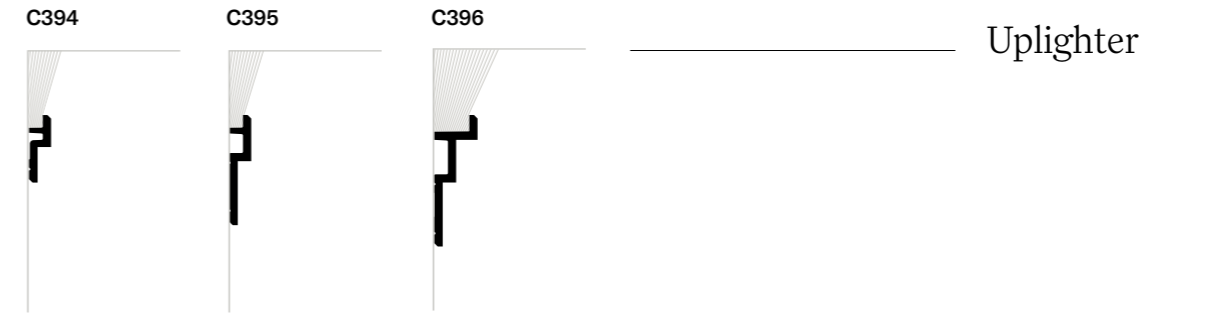

SX179 DIAGONAL
Duropolymer®
200 x 9,7 x 2,9 cm
Designed by Orio Tonini

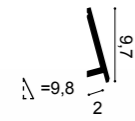

SX179 DIAGONAL
Duropolymer®
200 x 9,7 x 2,9 cm
Designed by Orio Tonini



CX197 U-STEPS
Duropolymer®
200 x 5 x 9,3 cm
Designed by Orio Tonini

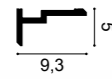

CX196 U-STEPS
Duropolymer®
200 x 11,3 x 4 cm
Designed by Orio Tonini

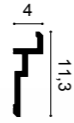

CX188 | CX188F
Duropolymer®
200 x 3,4 x 3 cm
Designed by Orio Tonini



CX189 | CX189F
Duropolymer®
200 x 2,7 x 2,7 cm
Designed by Orio Tonini

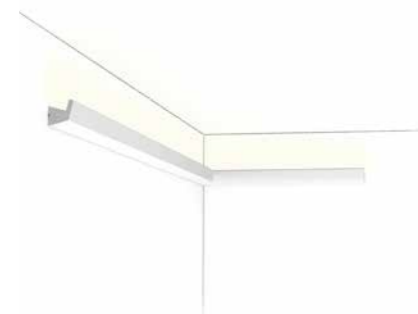
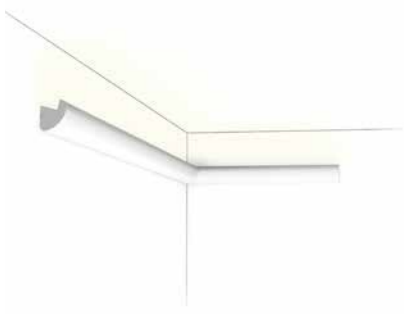

CX190 | CX190F U-PROFILE
Duropolymer®
200 x 2 x 3 cm
Designed by Orio Tonini



CX190 | CX190F U-PROFILE
Duropolymer®
200 x 2 x 3 cm
Designed by Orio Tonini



CX190 | CX190F U-PROFILE
Duropolymer®
200 x 2 x 3 cm
Designed by Orio Tonini

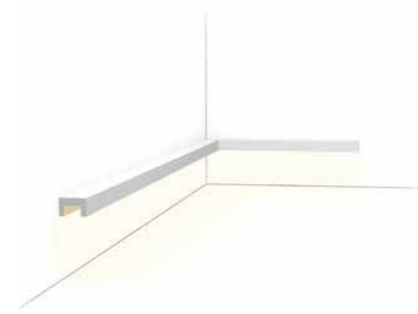
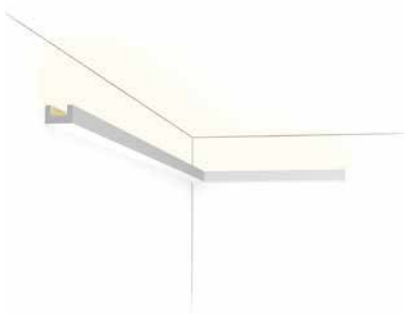

1. CX196 2. W115 p.102 3. CX190 p.118

Indirect lighting

C373 | C373F ANTONIO
Purotouch®
200 x 8 x 5 cm
Designed by Ulf Moritz

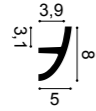

C374 ANTONIO
Purotouch®
200 x 18 x 5 cm
Designed by Ulf Moritz

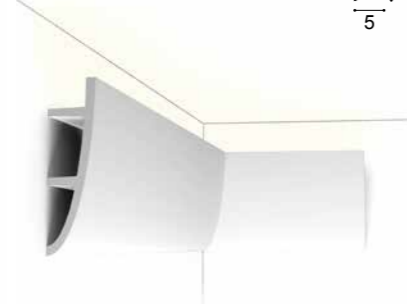
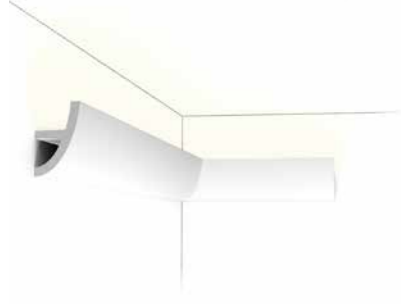
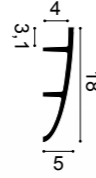

Antonio

C373 + C374



C373 + C373

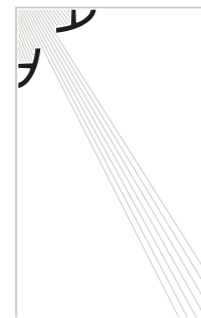

C374 + C991

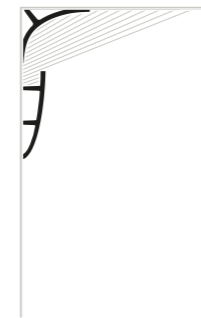

C373 + C373

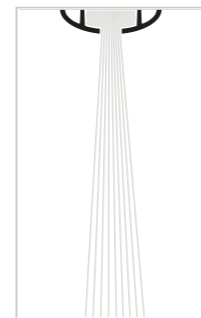

C374 + C374

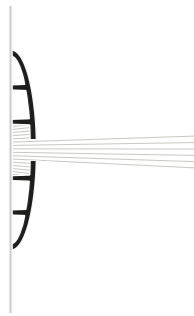

C373 + C374

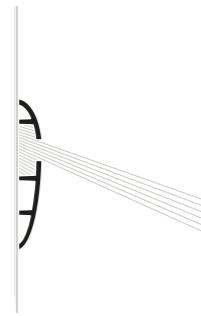

C373 + C373

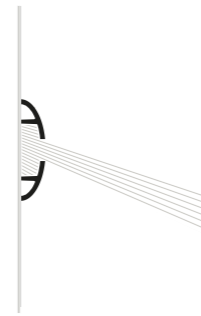

C374 + C373



C373 + C374

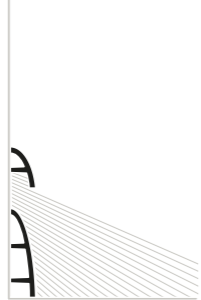

C374 + C374

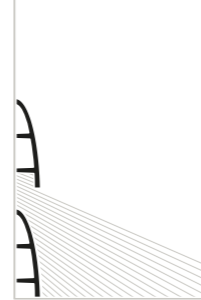

1. PX120 p.103 2. C394 p.77 3. C991 p.78 4. C361 p.129



Indirect lighting

C361 STRIPE
Purotouch®
200 x 5 x 5 cm
Designed by Pierre Daems

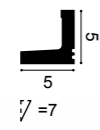

C362 CURVE
Purotouch®
200 x 5 x 5 cm
Designed by Pierre Daems

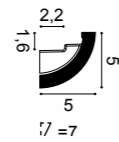

C991
Purotouch®
200 x 11 x 14 cm
Designed by Ulf Moritz

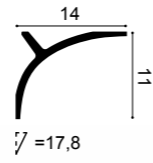

C371 SHADE
Purotouch®
200 x 18,5 x 5,8 cm
Designed by Ulf Moritz

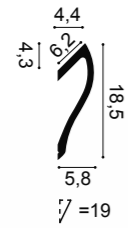

C991

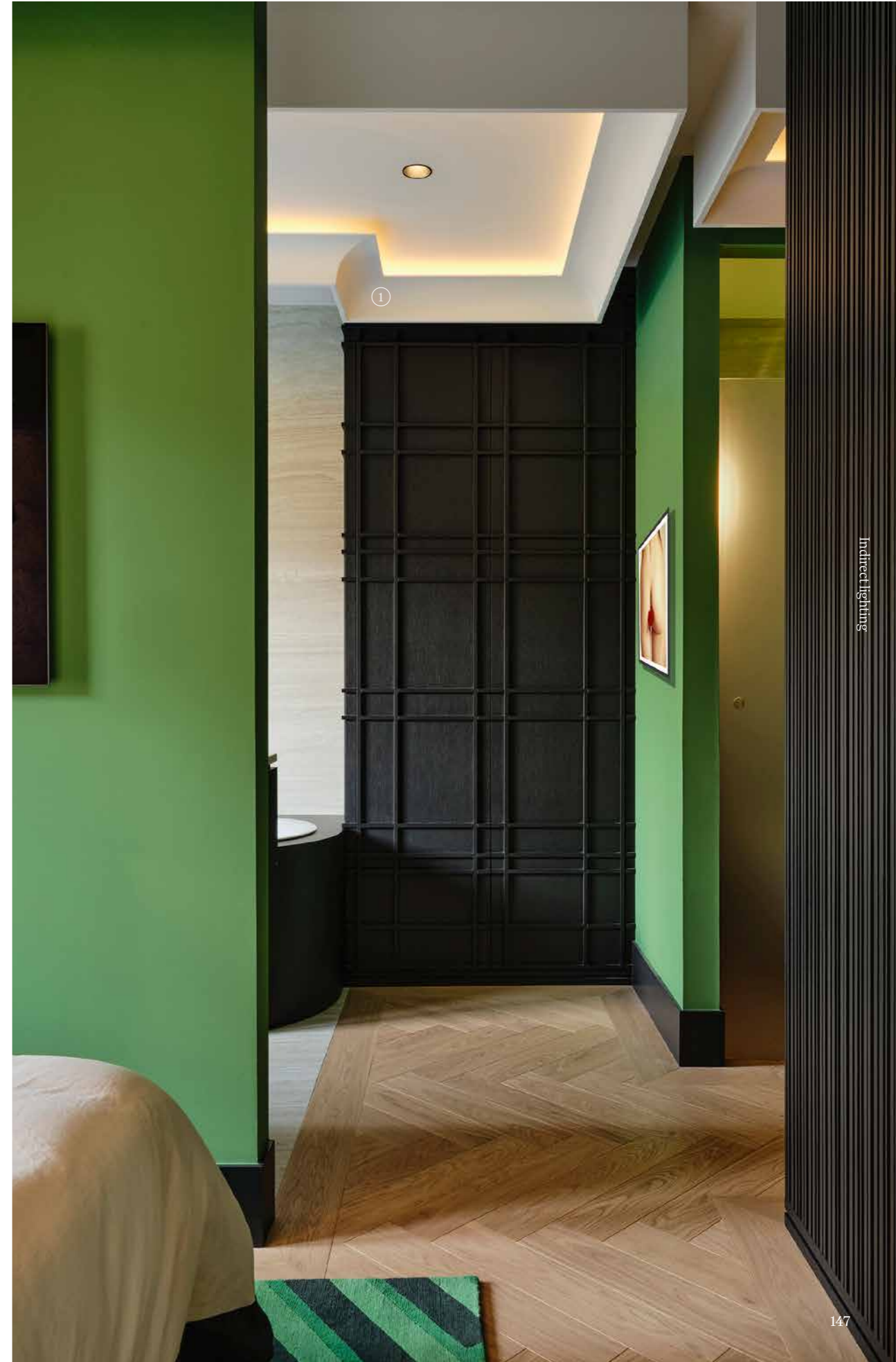

the perfect finish

PG. 158 -161



Deco elements

ORAC

Products

DECORATIEVE ELEMENTEN
ÉLÉMENTS DÉCORATIFS
ZIERELEMENTE
ELEMENTOS DE DECORACIÓN

Deco elements are the subtle whispers of personality that breathe life into a space. From grandiose flourishes to understated accents, we propose options to punctuate your interior design narrative with finesse, for you to find what feels right.

06

NL—
Decoratieve elementen zijn zachte echos van persoonlijkheden die een ruimte nieuw leven in blazen. Van imposante uitspattingen tot ingetogen accenten, wij bieden opties om jouw interieurverhaal met verfijning te accentueren, zodat je vindt wat echt bij je past.

FR—
Les éléments déco sont de subtils murmures de personnalité qui insufflent de la vie à un espace. Qu'il s'agisse d'ornements grandioses ou d'accents discrets, nous vous proposons des options pour ponctuer avec finesse votre récit de décoration intérieure, afin que vous trouviez ce qui vous convient.

DE—
Dekorative Elemente sind die subtilen Ausdrücke der Persönlichkeit, die einem Raum Leben einhauchen. Wir bieten Ihnen, von prunkvollen Verzierungen bis hin zu dezenten Akzenten, Optionen, um Ihre Inneneinrichtung mit Finesse zu unterstreichen und genau das zu finden, was sich für Sie richtig anfühlt.

ES—
Los elementos decorativos son matices delicados que dan vida y personalidad a un espacio. Desde los elementos más llamativos hasta matices los más discretos. Proponemos opciones para desarrollar la narrativa de tu diseño de interiores y poder encontrar lo que realmente conecta contigo.

Ceiling roses

ROZETTEN
ROSACES
ROSETTEN
ROSETONES

ORAC



¹ R64

R10 
Purotouch®
ø 15 x 4,2 - ø 2 cm



R11
Purotouch®
ø 19 x 3,6 - ø 3 cm



R12
Purotouch®
ø 19,5 x 1,8 - ø 1 cm



Products

R13 
Purotouch®
ø 28 x 3,1 - ø 2,5 cm



R14 
Purotouch®
ø 33 x 3 - ø 2,5 cm



R31 
Purotouch®
ø 38,5 x 2,7 - ø 3,5 cm



R17 
Purotouch®
ø 47 x 3,5 - ø 6,5 cm



R18
Purotouch®
ø 49 x 4,7 - ø 7 cm



R52 
Purotouch®
ø 69,5 x 4,8 - ø 12,5 cm



R73 
Purotouch®
ø 70 x 5,9 - ø 8 cm



R23
Purotouch®
ø 71 x 4,4 - ø 6 cm



R27
Purotouch®
ø 75 x 4,5 - ø 9 cm



R22
Purotouch®
77,5 x 53 x 3,6 cm



R24
Purotouch®
ø 79 x 6 - ø 8 cm



¹ **R64** 
Purotouch®
ø 95,2 x 4,8 - ø 7 cm



- R07**
Purotouch®
ø 26 x 3 - ø 5 cm
- R08**
Purotouch®
ø 38 x 4,2 - ø 5 cm
- R09** ⊕
Purotouch®
ø 48,5 x 3,7 - ø 6 cm



- R76**
Purotouch®
ø 62 x 4,1 - ø 10,5 cm



- ① **R77**
Purotouch®
ø 62 x 4,2 - ø 10,5 cm



- R40** ⊕
Purotouch®
ø 74,5 x 3,1 - ø 10 cm

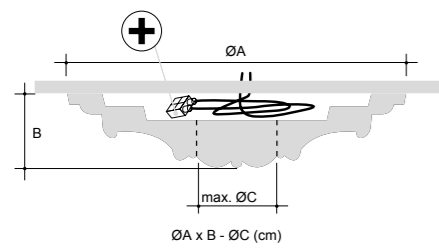

⊕ Room for cables

HOLTE VOOR KABELS
PLACE POUR LES CÂBLES
HOHLRAUM FÜR KABEL
ESPACIO PARA CABLES



① R77

Door frames

DEUROMLIJSTINGEN
ENCADREMENTS DE PORTES
TÜRUMRANDUNGEN
MARCOS PARA PUERTAS

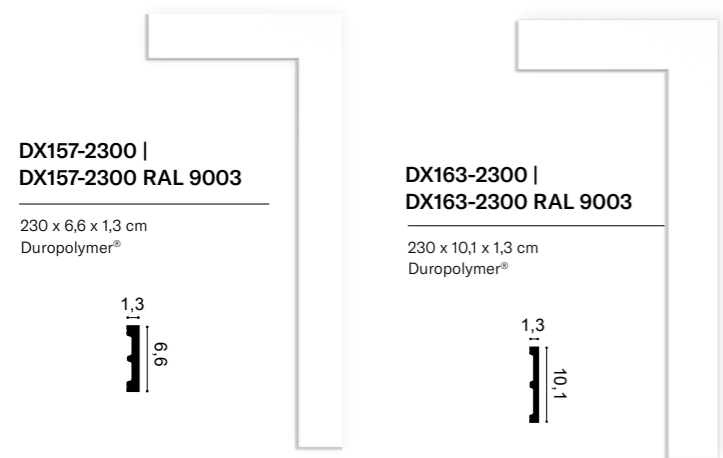

DX157-2300 | DX157-2300 RAL 9003

230 x 6,6 x 1,3 cm
Duropolymer®

DX163-2300 | DX163-2300 RAL 9003

230 x 10,1 x 1,3 cm
Duropolymer®

D210
Duropolymer®
9,6 x 9,6 x 3,5 cm

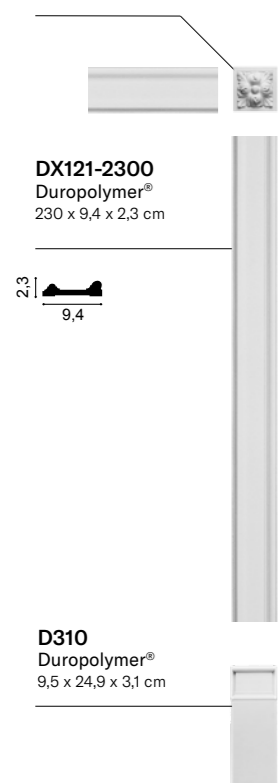

DX121-2300
Duropolymer®
230 x 9,4 x 2,3 cm

D200
Duropolymer®
9,6 x 9,6 x 3 cm

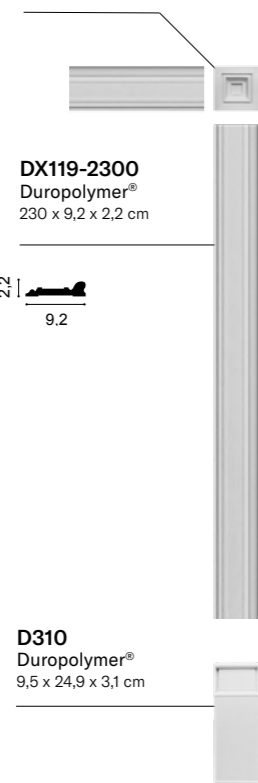

DX119-2300
Duropolymer®
230 x 9,2 x 2,2 cm

DX170-2300
Duropolymer®
230 x 11,9 x 3,2 cm

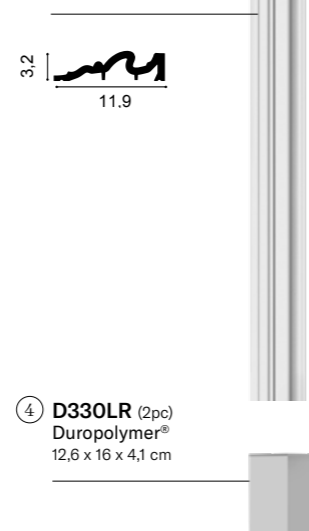

D330LR (2pc)
Duropolymer®
12,6 x 16 x 4,1 cm

DX174-2300
Duropolymer®
230 x 6 x 2,2 cm



D340
Duropolymer®
7 x 11 x 2,5 cm



1. D170 2. D401 3. DX170-2300 4. D330LR

Products

D400
Purotouch®
127,5 x 14,5 x 5,5 cm



D401
Purotouch®
127,5 x 14,5 x 5,5 cm



D402
Purotouch®
only for D400 and D401
14,5 x 12 x 5,5 cm



D170
Purotouch®
105 x 24,5 x 3,2 cm



PEDIMENTS
FRONTONS
PEDIMENTE
FRONTALES

Pediments

Deco elements

DEURPANELEN
PANNEAUX DE PORTES
TÜR PANEEL
PANELES PARA PUERTAS

Door panelling

D310
Duropolymer®
9,5 x 24,9 x 3,1 cm

D310
Duropolymer®
9,5 x 24,9 x 3,1 cm

D330LR (2pc)
Duropolymer®
12,6 x 16 x 4,1 cm

D340
Duropolymer®
7 x 11 x 2,5 cm

D504
Duropolymer®
55 x 22 x 1,7 cm

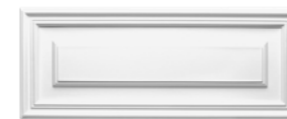

D503
Duropolymer®
55 x 55 x 1,7 cm



D507
Duropolymer®
55 x 90,5 x 1,7 cm



Full columns

VOLLE ZUILEN
COLONNES ENTIERES
VOLLSÄULEN
COLUMNAS COMPLETAS

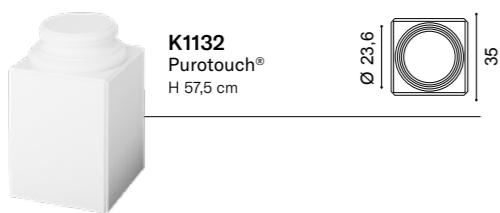
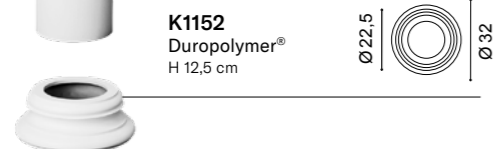
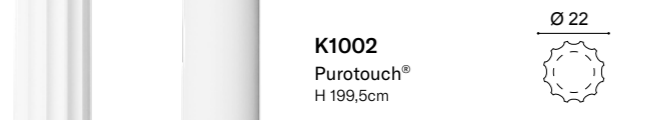
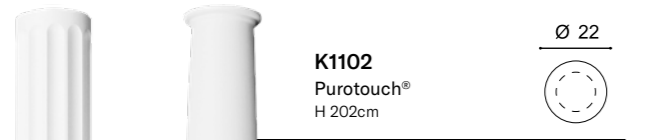

K1112 + K1002 + K1152 = 242 cm H
K1112 + K1002 + K1132 = 287 cm H max
K1122 + K1102 + K1152 = 242 cm H
K1122 + K1102 + K1132 = 287 cm H max

Half columns

HALVE ZUILEN
DEMI-COLONNES
HALBSÄULEN
MEDIAS COLUMNAS

ORAC

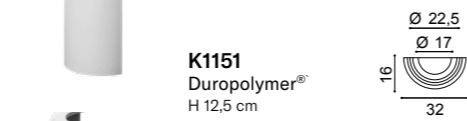
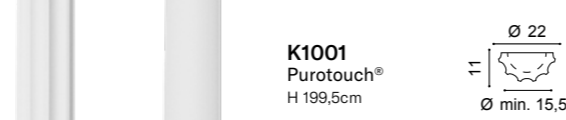
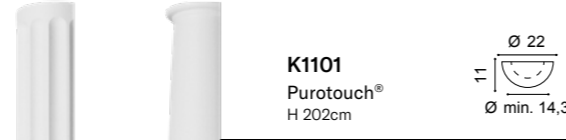

K1111 + K1001 + K1151 = 242 cm H
K1111 + K1001 + K1131 = 287 cm H max
K1121 + K1101 + K1151 = 242 cm H
K1121 + K1101 + K1131 = 287 cm H max

Products



PILASTERS
PILASTRES
PILASTER
PILASTRAS

Pilasters

1. K1122
2. K1002
3. K1152
4. K251
5. K250
6. K254



Deco elements

The perfect finish

07



DE PERFECTE AFWERKING
LA FINITION PARFAITE
DIE PERFEKTE INSTALLATION
EL ACABADO PERFECTO

We once vowed never to stop at what looks good. That's why our products stand the test of time, right down to the glue that holds them in place. Our installation products are the silent artisans behind the scenes, ensuring a seamless and straightforward installation of our architectural elements.

NL —

Onze producten zijn meer dan een lust voor het oog. Ze zijn gemaakt om de tand des tijds te doorstaan, tot aan de lijm die elk stuk op zijn plaats houdt. Onze montagmaterialen zijn de onzichtbare meesterhanden die zorgen voor een vlekkeloze en eenvoudige plaatsing van onze architecturale elementen.

FR —

Nous nous sommes promis de ne jamais nous arrêter à ce qui est beau. C'est pourquoi nos produits résistent à l'épreuve du temps, jusqu'à la colle qui les maintient en place. Nos produits d'installation sont les artisans silencieux de l'arrière-scène, qui garantissent l'installation simple et sans faille de nos éléments architecturaux.

DE —

Wir haben einst geschworen, niemals bei dem Halt zu machen, was gut aussieht. Deshalb überdauern unsere Produkte, bis hin zum Klebstoff, der sie an Ort und Stelle hält, die Zeit. Unsere Installationsprodukte sind die stillen Handwerker hinter den Kulissen und sorgen für eine nahtlose und unkomplizierte Installation unserer architektonischen Elemente.

ES —

Un día nos comprometimos a crear belleza perdurable. Por eso nuestros productos resisten el paso del tiempo, ¡incluso el adhesivo que los mantiene en su sitio! Nuestros productos de instalación son como artesanos silenciosos entre bastidores, que garantizan una instalación perfecta y sencilla de nuestros elementos arquitectónicos.

Surface and atmosphere

OMGEVING & ONDERGROND
ENVIRONNEMENT & SURFACE
UMGEBUNG & UNTERGRUND
AMBIENTE & SUPERFICIE

Storage and installation conditions: Store profiles and adhesives at room temperature and wait 24 hours before installing.



Opslag- en plaatsingsvoorwaarden:
Plaats profielen en lijmen 24 uur vóór de installatie op kamertemperatuur.



Conditions d'installation et de stockage:
Stockez les profils et les colles à température ambiante 24 heures avant la pose.



Lager- und Installationsbedingungen:
Profile und Kleber 24 Stunden vor Verlegung bei Zimmertemperatur lagern.

Condiciones de almacenamiento y de instalación:
Colocar los productos y adhesivos a temperatura ambiente 24 horas antes de la instalación.



Dust free
Stofvrij
Sans poussière
Staubfrei
Libre de polvo



Sand and wash surface
Schuur en reinig de ondergrond
Poncez et nettoyez la surface
Schleifen und reinigen Sie den Untergrund
Superficie lisa y limpia



Flat wall & ceilings
Vlakke wand en plafond
Mur et plafond plats
Plane Wand und Decke
Paredes y techos lisos



Dry
Droog
Sec
Trocken
Seco



No grease
Vetvrij
Sans graisse
Fettfrei
Sin grasa

Decofix adhesives

DECOFIX LIJMEN
COLLES DECOFIX
DECOFIX KLEBER
DECOFIX ADHESIVOS



Interior, porous and dry surface
Binnen, poreuze en droge ondergronden
Pose à l'intérieur, surfaces poreuses, pièces non humides
Innen, poröse/saugfähige und trockene Untergründe
Interior, superficies porosas y secas



Heavy profiles
Zware lijsten
Profils lourds
Schwere Profile
Perfiles Pesados



Exterior, non-porous and humid surfaces and 3D Wall Covering
Buiten, niet-poreuze en vochtige ondergronden en 3D wandbekleding
Pose à l'extérieur, surfaces non poreuses, environnement humide et revêtements muraux 3D
Außen, nicht-poröser/saugfähiger Untergrund und Feuchträume
Exterior, superficies no porosas, ambientes húmedos y paneles 3D



Seal wall/ceiling
Verbinding muur/plafond
Collage mur/plafond
Verbindung Wand/Decke
Adherencia techos/paredes



DecoFix Pro
Strong, water-based acrylic installation adhesive
FDP500 310ml | 7 > 8m



DecoFix Power
Very strong MS-Polymer-based installation adhesive
FDP700 290ml | 7 > 8m



Joints between mouldings*
Verbinding tussen profielen
Joints entre les profils
Nahtverbindungen zwischen Profilen
Uniones entre los perfiles



DecoFix Ultra
Polymer-based adhesive
FX400 270ml | min. 80m



Filler & finishing
Vullen en afwerking
Enduit et finition
Verfugen und Endbearbeitung
Relleño y acabado



DecoFiller
Acrylic filler
FL300 310ml | > 30m



DecoFix Pro



FDP500 310ml
> 7 – 8m

Extra strong installation adhesive for porous surfaces and interior applications
· Strong, water-based acrylic glue
· Long-lasting seal between mouldings and the wall and/or ceiling
· Remove with humid sponge or cloth
· Should be kept frost free
· Paintable after hardening (min. 24 hours)

DecoFix Power



FDP700 290ml
> 7 – 8m

Extra strong MS polymer glue for new build, all exterior applications, non-porous (tiles, glass, ...) surfaces, damp environments and 3D wall covering
· Remove with soap solution
· Paintable after hardening (min. 24 hours)

DecoFix Ultra



FX400 270ml
> 80m

White, polymer-based adhesive for joints between mouldings
· Apply sufficient DecoFix Ultra in every joint.
· Push profiles strongly against each other and remove excess glue with a painter's knife before hardening.
· Use FL300 DecoFiller if needed and finish with sandpaper.
· Can be painted after 24 hrs.

DecoFiller



FL300 310ml
> 30m

Ready to use lightweight acrylic filler
· For shrink-proof finishing of gaps (between decorative profiles after adhesion, between wall and profiles, cracks and irregularities in profiles or on walls
· Rapidly repaintable (after 15 min.)
· Does not crack

Extra sterke installatielijm voor poreuze ondergrond en binnentoepassingen
· Sterke acrylijm op waterbasis
· Langdurende verbinding tussen profielen en muur en/of plafond
· Verwijder met een vochtige spons of doek
· Vorstvrij bewaren
· Overschilderbaar na uitharding (min. 24u)

Extra sterke MS-polymeerlijm voor nieuwbouw, buitengebruik, op niet-poreuze (tegels, glas,...) ondergrond, in vochtige ruimtes en voor 3D wandbekleding
· Verwijder met een zeepoplossing
· Overschilderbaar na uitharding (min. 24u)

Witte lijm op polymeerbasis voor verbinding tussen profielen
· Gebruik voldoende DecoFix Ultra in elke naadverbinding op 1 zijde van het reeds geplaatste profiel.
· Duw beide profielen stevig tegen elkaar aan
· Verwijder de overtollige lijm met een schildersmesje voor uitharding.
· Gebruik FL300 DecoFiller indien nodig en werk af met schuurpapier.
· Overschilderbaar na 24u

Kant-en-klare lichte vulpasta op acrylbasis
· Voor krimpvrij afwerken van naden (tussen sierprofielen na lijmen, tussen wand en profiel, tussen wanden onderling en tussen wand en plafond), scheuren en oneffenheden in profielen of binnenmuren
· Snel overschilderbaar (na 15min.)
· Kraakt niet

Colle d'installation ultra forte pour surfaces poreuses et applications intérieures
· Colle forte à base d'eau et d'acrylique
· Joint longue durée entre les moulures et le mur et/ou le plafond
· Retirez à l'aide d'une éponge ou d'un chiffon humide
· Doit être conservé à l'abri du gel
· Peut être peinte après séchage (min. 24h)

Colle au MS polymère extra forte pour constructions nouvelles, utilisation extérieure, surfaces non poreuses (carrelage, verre, etc...), environnements humides et revêtements muraux 3D
· Enlevez à l'aide d'une solution savonneuse
· Peut être peinte après séchage (min. 24h)

Colle blanche à base de polymères pour les joints entre profils
· Appliquez une quantité suffisante de DecoFix Ultra pour chaque joint sur le côté du profil déjà installé.
· Pressez les deux profils fortement l'un contre l'autre.
· Éliminez les excès de colle en utilisant un couteau peinture avant le durcissement.
· Utilisez du FL300 DecoFiller si nécessaire et finir avec du papier de verre.
· Peut être peint après 24 hrs.

Enduit léger prêt à l'emploi à base d'acrylique
· Pour une finition irréversible de joints (entre profils décoratifs après adhésion, entre murs et profils, entre mur et plafond et murs entre eux), fissures, trous et irrégularités dans les profils ou les murs
· Peut être recouvert rapidement (après 15 min.)
· Ne se fissure pas

Extra starker Montagekleber auf saugenden Untergründen und für den Innenbereich
· Starker, wasserbasierter Acrykleber
· Langhaltende Verbindung zwischen Profilen und Wand und/oder Decke
· Mit leicht feuchtem Schwamm oder Tuch entfernen
· Frostfrei lagern
· Anstrichverträglich nach Aushärtung (min. 24 St.)

Besonders starker MS-Polymerkleber für Neubauten, den Außenbereich, auf nicht porösem (Fliesen, Glas, ...) Untergrund, Feuchträumen und für 3D Wandvertäfelung
· Mit Seifenlösung entfernen
· Anstrichverträglich nach Aushärtung (min. 24 St.)

Weißer Klebstoff auf Polymerbasis für Nahtverbindungen zwischen Profilen
· Verwenden Sie ausreichend DecoFix Ultra in jeder Dekoprofilen nach der Montage. Kann ebenfalls für das Verfüllen der Fugen bzw. Lücken zwischen dem Profil und dem Untergrund auf dem es montiert wurde verwendet werden. Beschädigungen an Wand oder Profil können mit dem Füllstoff nachgearbeitet werden.
· Schnell überstreichbar (nach 15 min.)
· Reißt nicht

Gebruiksrijpe Leichtspachtelmasse auf Acrylbasis
· Zur schrumpffreien Endbearbeitung von Fugen zwischen Dekoprofilen nach der Montage. Kann ebenfalls für das Verfüllen der Fugen bzw. Lücken zwischen dem Profil und dem Untergrund auf dem es montiert wurde verwendet werden. Beschädigungen an Wand oder Profil können mit dem Füllstoff nachgearbeitet werden.
· Schnell überstreichbar (nach 15 min.)
· Reißt nicht

Adhesivo superfuerte para soportes porosos y aplicaciones en el interior
· Fuerte, cola acrílica con base de agua
· Gran adherencia del producto en techos o paredes
· Eliminar con una esponja o paño húmedo
· Debe guardarse en un ambiente seco
· Pintable después de endurecimiento (min. 24 horas)

Adhesivo MS polímero extra fuerte para construcciones nuevas, aplicaciones de exterior, superficies no porosas (cerámica, vidrio, ...), lugares húmedos y revestimientos de pared 3D.
· Eliminar con agua y jabón
· Pintable después de endurecimiento (min. 24 horas)

Adhesivo blanco a base de polímeros para juntas entre perfiles
· Aplica una cantidad suficiente de DecoFix Ultra para cada junta en el lado del perfil ya instalado.
· Presiona firmemente los dos perfiles entre sí.
· El sobrante podrá eliminarse con una espátula antes del endurecimiento.
· Utilizar FL300 DecoFiller si fuera necesario y reparar con papel de lija.
· Se puede pintar después de 24 horas.

Masilla ligera lista para usar en base acrílica
· Especial para un buen acabado final de juntas, indicada también para transiciones de los perfiles con las paredes y/o techos. Ideal para sellar pequeñas grietas e irregularidades que nos podemos encontrar en las instalaciones
· Se puede lijar y pintar fácilmente, pasados 15 min. de su aplicación
· No merma, ni fisura

Tools

TOEBEHOREN
ACCESSOIRES
ZUBEHÖR
ACCESORIOS



FB15

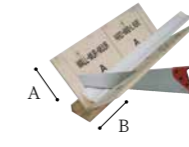

FB300
A: 29,7 cm | B: 29,1cm

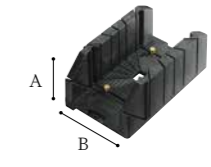

FB13
A: 12,5 cm | B: 15,5 cm



A38

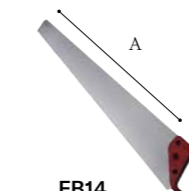

FB14
A: 60 cm



FB10
A: 27,5 cm | B: 22 cm

Installation videos & manuals

VISIT WWW.ORACDECOR.COM/INSTALLATION OR SCAN THE QR CODE



Flexible products

ORAC

08

Products

FLEXIBELE PRODUCTEN
PRODUITS FLEXIBLES
FLEXIBLE PRODUKTE
PRODUCTOS FLEXIBLES

You may expect walls to be straight by nature. But we invite you to imagine a flowing interior. Many of our solutions are flexible, following or effectively suggesting a curve in a wall. As far as we're concerned, a rounded corner should never be out of the question.

NL —

Misschien verwacht u dat muren recht zijn, dat is tenslotte wat we vaak zien. Maar wat als u zich laat leiden door de stroming van een interieur dat speelt met lijnen en rondingen? Onze ontwerpen buigen en weven, ze suggereren de elegantie van een curve. Want voor ons is een afgeronde hoek altijd een optie.

FR —

On peut s'attendre à ce que les murs soient droits par nature. Mais nous vous invitons à imaginer un intérieur fluide. Nombre de nos solutions sont flexibles, suivant ou suggérant efficacement la courbe d'un mur. Car pour nous, un coin arrondi ne devrait jamais être exclu.

DE —

Sie erwarten vielleicht, dass Wände von Natur aus gerade sind. Wir laden Sie jedoch ein, sich ein fließendes Interieur vorzustellen. Viele unserer Lösungen sind flexibel und folgen einer Kurve in einer Wand oder deuten sie effektiv an. Denn für uns sollte eine abgerundete Ecke niemals unmöglich sein.

ES —

Es común esperar que las paredes sean rectas por naturaleza. Pero te invitamos a imaginar un interior orgánico. Muchas de nuestras soluciones son flexibles, siguiendo o sugiriendo una curva en la pared. Porque para nosotros, una esquina redondeada nunca está de más.

Flex Radius	R min in cm	R* min in cm	R**min in cm	Flex Radius	R min in cm	R* min in cm	R**min in cm	Flex Radius	R min in cm	R* min in cm	R**min in cm
C211F	250			CX199F	200			SX165F	40		
C213F	280			DX174F	60	300		SX172F	35		
C215F	160			P3020F	50	180		SX173F	45		
C217F	380			P4020F	40	200		SX180F	45		
C220F	400			P4025F	70			SX182F	35	100	
C230F	150			P5021F	20	70		SX183F	40		
C240F	270			P7070F	30	230		SX184F	45		
C250F	70			P8020F	40	130		SX187F	40		
C304F	250			P8030F	20	70		SX194F	25	80	
C321F	140			P8040F	30			SX195F	30		
C325F	300			P8050F	80	200		W108F	30		40
C326F	500			P9010F	40	310		W109F	30		40
C331F	420			P9050F	20	60		W110F	30		40
C333F	300			P9900F	20	250		W111F	30		40
C334F	380			PX103F	20	80		W114F	30		40
C339F	380			PX120F	30	110		W116F	30		40
C341F	400			PX144F	20	220		W119F	30		40
C373F	100			PX175F	30	80		W214F	30		40
C901F	600			PX198F	70			WX205F	30		40
C902F	600			PX201F	30	80		WX210F	30		40
CX100F	200			PX202F	60	150		WX211F	30		40
CX106F	360			PX209F	20	70		SX207F	40		
CX109F	160			SX104F	40						
CX110F	180			SX105F	30						
CX123F	280			SX118F	40						
CX124F	160			SX137F	40						
CX127F	240			SX138F	40						
CX132F	70			SX155F	30						
CX188F	110			SX157F	35	260					
CX189F	90			SX162F	20	80					
CX190F	30	130		SX163F	35						

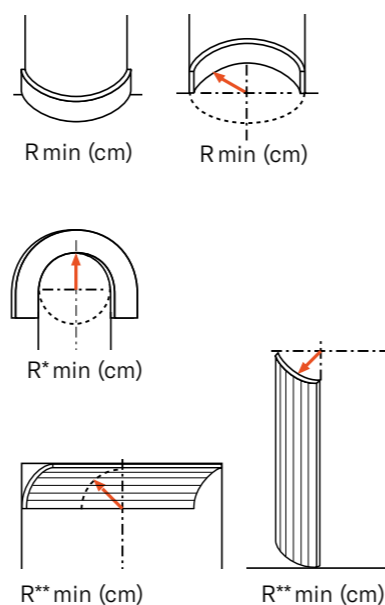

1. W108F p.164

Index

C

C200	69
C201	73
C211 C211F	40, 41, 42, 50, 51, 70, 71
C212	73
C213 C213F	69, 70
C215 C215F	69
C216	69
C217 C217F	69
C219	73
C220 C220F	69
C230 C230F	69
C240 C240F	76
C250 C250F	76
C260	76
C301	69
C303	73
C304	73
C305	40, 41, 42, 50, 51, 70, 71
C305 + C211	40, 41, 42, 50, 51, 70, 71
C305 + C213	70
C307	70
C307 + C307A	70
C307A	40, 41, 42, 50, 51, 70, 71
C321 C321F	74
C322	69
C323	136
C324	136
C325	67
C326	67
C327	67
C331	73
C332	34, 35, 36, 37, 74, 75
C333 C333F	73
C334 C334F	73
C336	68
C338	68
C338A	68
C338B	68
C339 C339F	74
C340	74, 83
C341 C341F	66, 83
C342	66, 83
C343	46, 47, 52, 53, 66, 83, 117
C344	66
C352	137
C353	80
C354	80
C355	80, 81
C356	80
C357	137
C360	80
C361	145, 146
C362	146
C371	146
C373 C373F	144
C374	144
C380	139
C381	139

C382	139
C383	139
C390	27, 79, 83, 141
C391	25, 26, 30, 79, 83, 141
C392	27, 79
C393	25, 26, 30, 79
C394	30, 79, 83, 141, 145
C395	79, 83, 141
C396	79, 83, 141
C400	80
C422	70
C602	80
C900	73, 137
C901 C901F	73, 137
C902 C902F	73, 137
C990	14, 15, 76, 77
C990 + 2x P9900	77
C990 + P9900	77
C991	77, 81, 83, 145, 146
C991 + 2x P9900	31, 77
C991 + P9900	77
CB500N	90
CB501N	90
CB502N	90
CB503N	91
CB510N	90
CB511N	90
CB512N	90, 91
CB520N	90
CB521N	90
CB522N	90
CB523N	90
CB524N	91
CB525N	90
CX100 CX100F	84
CX106 CX106F	84
CX107	85
CX108	85
CX109 CX109F	86
CX110 CX110F	84
CX111	85
CX112	85
CX115	86
CX123 CX123F	84
CX124 CX124F	84
CX126	86
CX127 CX127F	84
CX129	85
CX132	86
CX133	86
CX134	131
CX141	86
CX148	86
CX160	54, 89
CX161	89
CX176	86
CX177	85
CX188 CX188F	14, 15, 30, 31, 76, 142
CX189 CX189F	142
CX190 CX190F	18, 19, 25, 26, 28, 29, 87, 101, 102, 116, 118, 120, 130, 142, 143

CX192	86
CX196	83, 87, 102, 142
CX197	83, 87, 130, 142
CX199 CX199F	84
CX203	84

D

D170	154
D200	154
D210	154
D310	154
D330LR	41, 52, 105, 154
D340	154
D400	155
D401	155
D402	155
D503	155
D504	155
D507	155
DX119-2300	128, 155
DX121-2300	128, 155
DX157-2300	155
DX163-2300	155
DX170-2300	41, 52, 105, 112, 128, 154, 155
DX174-2300 DX174F	128, 155

F

F30	107
------------	-----

K

K200	157
K201	157
K202	157
K250	157
K251	157
K254	157
K1001	156
K1002	156
K1101	156
K1102	156
K1111	156
K1112	156
K1121	156
K1122	156
K1131	156
K1132	156
K1151	156
K1156	156

P

P20	133
P101A	133
P801C	133
P1020	125
P3020A	39, 132, 133
P3020 P3020F	125
P3070	126
P3071	126
P4020A	133
P4020 P4020F	40, 41, 42, 46, 52, 124, 128
P4025 P4025F	124
P5021 P5021F	126
P6020	125
P7020	125
P7030	125
P7070 P7070F	27, 114, 119, 126
P8020 P8020F	46, 52, 66, 67, 75, 84, 117, 124, 125, 128

P8030C	133
P8030D 133	
P8030 P8030F	38, 39, 51, 54, 67, 71, 84, 88, 124, 125

P8040 P8040F	124
P8050 P8050F	39, 50, 124, 125, 132
P8060	126
P9010 P9010F	48, 49, 112, 124, 127
P9020	124
P9040	124
P9050 P9050F	48, 49, 112, 126, 127
P9900 P9900F	24, 31, 77, 126
P9901	126
PX103 PX103F	91, 110, 129
PX103A	133
PX113	129
PX116	129
PX117	129
PX120 PX120F	129
PX120A	133
PX144 PX144F	129
PX147	130
PX169	130
PX175 PX175F	129
PX198 PX198F	87, 102, 116, 118, 130
PX201 PX201F	129
PX202 PX202F	129
PX209 PX209F	14, 15, 36, 97, 98, 99, 130, 131, 136

R

R07	152
R08	152
R09	152
R10	150

R11	150
R12	150
R13	151
R14	151
R17	151
R18	151
R22	151
R23	151
R24	151
R27	151
R31	151
R40	152
R52	151
R64	151
R73	151
R76	152
R77	152

S

SX104 SX104F	115
SX105 SX105F	112
SX118 SX118F	93
SX125	116
SX137 SX137F	113
SX138 SX138F	34, 36, 37, 105, 113
SX155 SX155F	48, 112
SX156	115
SX157 SX157F	89, 111, 118, 131
SX159	126
SX162 SX162F	89, 111, 118, 131
SX163 SX163F	89, 111, 118, 131
SX165 SX165F	111
SX168	118, 131
SX171	111, 121
SX172 SX172F	116
SX173 SX173F	111
SX179	116, 142
SX180 SX180F	25, 27, 30, 114, 119, 139, 140
SX181	114, 119
SX182 SX182F	14, 17, 89, 99, 111, 119, 131
SX183 SX183F	89, 111, 119, 131
SX184 SX184F	89, 111, 119, 131
SX185	111, 121
SX186	111, 121
SX187 SX187F	114, 119
SX191	51, 52, 53, 67, 71, 115
SX193	113
SX194 SX194F	19, 24, 89, 116, 118, 131
SX195 SX195F	112
SX206	46, 113, 128
SX207 SX207F	26, 95, 118, 130, 131
SX212 <small>NEW</small>	119, 131

W

W100	106
W101	106
W105	106
W106	106
W107	106
W108 W108F	96, 165
W109 W109F	48, 49, 98, 117, 136
W110 W110F	20, 21, 36, 96, 97
W111 W111F	25, 87, 101
W112	103
W113	103
W114 W114F	18, 19, 98
W116 W116F	25, 87, 121
W115	16, 102, 143
W119 W119F	25, 87, 121
W120	104, 105, 113, 115
W121	104, 105, 113, 115
W122	104, 105
W123	104, 105
W130	103
W210	98, 136
W213 <small>NEW</small>	96, 97
W214 W214F <small>NEW</small>	34, 35, 36, 37, 96, 97
W215 <small>NEW</small>	34, 35, 36, 37, 96, 97
W216 <small>NEW</small>	26, 102, 103
W217 <small>NEW</small>	14, 17, 99
W218 <small>NEW</small>	14, 17, 99
WX204	95
WX204-2600	95
WX205 WX205F	95
WX205-2600	95
WX210 WX210F <small>NEW</small>	36, 95, 97
WX210-2600	36, 95, 97
WX211 WX211F <small>NEW</small>	36, 95, 97
WX211-2600	36, 95, 97

Colofon

Concept

Base Design
zwerm.studio

Graphic design

zwerm.studio

Special thanks to

BLCN Design	blcn-design.com	8
The HUB Ghent	thehub.be	18–19
Maison Numéro 20	maisonnumero20.fr	20–21
Atelier DAAA	atelierdaaa.com	28–29, 88, 120
Marie-Emilie Geerinckx	marieemiliegeerinckx.be	30–31, 140
Aboco	aboco.be	38–39, 132
Geoffroy Van Hulle	geoffroyvanhulle.com	40–41, 42–43, 54–55, 76, 84
Van Damme - Vandeputte architects	vandammevandeputte.com	50–51, 71, 122, 125
LOFT4C	loft4c.be	52–53
Anthony Boelaert	anthonyboelaert.be	68
Interieurprojects	interieurprojects.com	81
Sur Mesure Interieur	surmesure-interieur.be	75, 82
Sofie de Kruijff	thehomestyleclub.com	98
Atelier En Aparté	atelierenaparte.com	106
Blume Studio	blumestudio.es	107
Madrid Forest	madridforest.com	107
Hotel Du Parc Oostende	hotelduparc.be	110
D-ZAJN	d-zajn.be	110
Hotel Astoria De Haan	hotelastoria.be	115
Roelfien Vos	roelfienvos.com	145, 147
Perfect Living	perfectliving.be	150
Alina Vilhjálmsdóttir		153
Eichholtz	eichholtz.com	157
Belén Imaz	belenimaz.com	107
Cafeine	cafeine.be	18–19, 28–29, 50–51, 71, 88, 115, 120, 122, 125
Damon De Backer	damondebacker.com	43
Didier Delmas	didierdelmas.com	20–21
DVO Photographic	dvo-photographic.be	81
Hannelore Veelaert	hanneloreveelaert.com	8, 38–39, 110, 132
Lotte van Uittert	lottevanuittert.com	98
Rebecka Oftedal		106
Stephanie Mathias	stephaniemathias.be	75, 82
Tijs Verweken	tijserverveken.com	30–31, 40–41, 42–43, 52–53, 54–55, 76, 84, 140
Verne	verne.be	
Willem Van Puyenbroeck	willemvanpuyenbroeck.com	150

ORAC Headquarters | nv Orac sa

Biekorfstraat 32
8400 Ostend, Belgium
T +32 59 80 32 52
info@oracdecor.com

ORAC Benelux

Biekorfstraat 32
8400 Ostend, Belgium
NL: T +31 852 08 40 59
BeLux: T +32 59 79 02 82
benelux@oracdecor.com

ORAC Deutschland

Boltensternstraße 159A
50735 Köln, Deutschland
T +49 221 747 499 39
deutschland@oracdecor.com

ORAC Österreich

T +43 662 23 49 27
oesterreich@oracdecor.com

ORAC France

13 Rue Séguier
75006 Paris, France
T +33 188803631
france@oracdecor.com

ORAC Export

T +32 59 79 02 83
export.cs@oracdecor.com

ORAC Slovakia s.r.o.

Kpt. Nalepku 6
08271 Lipany, Slovakia
T +421 232 784 952
slovakia@oracdecor.com

ORAC España

C/ del Rosselló, 229
08008 Barcelona, España
T +34 938 56 49 00
spain@oracdecor.com

ORAC (UK) Ltd.

216 Afon Building, Worthing Road
Horsham, RH12 1TL UK
T +44 1403 240 102
uk@oracdecor.com

Orac Ireland

T +35 381 8000 280
ireland@oracdecor.com

ORAC Italia srl

Corso Giacomo Matteotti, 5/H
23900 Lecco (LC), Italia
T +39 0341 362062
italia@oracdecor.com

ORAC Polska

ul. Pomorska 106A
91-402 Łódź, Polska
T +48 42 203 60 56
polska@oracdecor.com

ORAC Schweiz

T 0800 562 118
switzerland@oracdecor.com

Guarantee terms and conditions apply if provided installation instructions have been followed to the letter. Fire retardant standards. In many interiors and projects strict fire regulations are imposed. Therefore, ORAC has implemented a number of solutions depending on the country and its regulations. Please contact us for more information. The information in this catalogue is without engagement. Changes and discrepancies in sizes or/and shapes against those stated in the catalogue can occur. This catalogue and the design embodied within are protected by copyright law and international treaties. Unauthorized reproduction of the catalogue, any portion of it or the reproduction of the designs embodied therein may result in severe civil and criminal penalties and will be prosecuted to the maximum.

Further legal information can be found on: www.oracdecor.com/nl/disclaimer.



This catalogue is printed on FSC-certified paper.

ORAC PAPER

WWW.ORACDECOR.COM

